



Attrezzature professionali per posatori 

Professional tools for tile layers 

Herramientas profesionales para colocadores 

1946



KAT-LIST 52

2025



LANGUAGES AVAILABLE: DE - FR

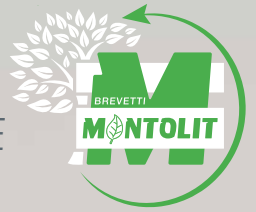

for EARTH and PEOPLE



Brevetti Montolit è nata nel 1946 dalle geniali intuizioni del Cav. Montoli Vincenzo e non si è più fermata; da allora l'evoluzione è stata incessante. Pilastrini portanti dalla nascita sono: propensione all'innovazione, creatività e continua voglia di migliorarsi indispensabili per generare prodotti unici coperti da brevetti internazionali.

Brevetti Montolit was conceived in 1946 by the brilliant mind of Vincenzo Montoli, and never stopped after that; since then, the evolution has been incessant. Since its foundation, its cornerstones have been: propensity for innovation, creativity, and continuous desire to improve, essential for generating unique products covered by international patents.

Brevetti Montolit nace en 1946 de las brillantes iniciativas de Vincenzo Montoli y desde entonces no se ha vuelto a detener, la evolución ha sido incesante. Los principales pilares desde su nacimiento han sido la propensión a la innovación, la creatividad y las continuas ganas de superación, indispensables para generar productos únicos amparados por patentes internacionales.

2023

1974

1946





IT NOVITA'
GB NEWS
ES NOVEDAD

pg. 02 > 03



IT Tagliapiastrelle manuali
GB Manual tile cutters
ES Cortadoras manuales de baldosas

pg. 04 > 15

Ricambi | Spare parts | Recambios

pg. 16 > 17

300 PROJECT 300

IT Tecnologie per la lavorazione delle lastre ceramiche
GB Technologies for processing ceramic slabs
ES Tecnologías para el procesamiento de losas cerámica

pg. 18 > 38



IT Movimentazione di grandi lastre
GB Handling system for slabs
ES Movilización de grande losas

pg. 20 > 27



IT Sistemi di taglio per il grande formato
GB Large format cutting systems
ES Sistemas de corte de gran formato

pg. 28 > 33



IT Ventose battenti per piastrelle e lastre
GB Thumping suction cups for tiles and slabs
ES Ventosas vibrante para baldosas y losas

pg. 34 > 35



IT Sistema di profilatura a secco
GB Dry profiling system
ES Sistema de perfilado en seco

pg. 36 > 38



IT Attrezzature elettriche
GB Electric equipment
ES Equipos electricos

pg. 39 > 45



IT Attrezzature manuali per la posa
GB Manual equipment for the laying of tiles
ES Equipos manuales para la instalación de baldosas

pg. 46 > 49



IT Tranciablocchetti / tagliategole
GB Paving block cutters / Roof tiles cutter
ES Cortadoras de bloques manual / Cortadora de tejas

pg. 50 > 51

Ricambi | Spare parts | Recambios

pg. 52 > 53



IT Lame circolari per legno
GB Circular blades for timber
ES Cuchillas circulares para madera

pg. 54



IT Guida assistita per tagli perfetti
GB Assisted guide for perfect cuts
ES Guía asistida para cortes perfectos

pg. 55



IT Utensili diamantati DNA
GB DNA diamond tool
ES Herramientas de diamantes DNA

pg. 56 > 68



IT Dischi diamantati
GB Diamond blades
ES Discos diamantados

pg. 70 > 84



IT Foratura
GB Drilling
ES Perforación

pg. 85 > 96



IT Lavorazioni speciali
GB Special works
ES Obras especiales

pg. 97 > 106



IT Espositori modulari
GB Assembling displays
ES Dispositivos modulares

pg. 107 > 108

Condizioni di vendita | Term of sales | Condiciones de venta

pg. 109

NUOVI prodotti

pg.
11

CARAPAX

- IT Protezione elastica per tagliapiastrelle **Masterpiuma P5**.
- GB Elastic protection for **Masterpiuma P5** tile cutters.
- ES Protección elástica para cortadoras de baldosas **Masterpiuma P5**.



P5-TOP

pg.
9

P5 131/161 + Carapax + Atlas

pg.
20

GECO ROBOT

- IT Sistema robotizzato a batteria per la movimentazione delle lastre.
- GB Battery powered robotic system for handling slabs.
- ES Sistema robótico a baterías para manipulación de losas.



pg.
24

SUPERLIFT e-power

- IT Sistema modulare di movimentazione lastre.
- GB Modular handling system for slabs.
- ES Sistema modular de movilización de losas.



NEW products

pg. 23

GECONE

- IT Ventosa super professionale a batteria.
- GB Super professional battery-powered suction cup.
- ES Ventosa super profesional a batería.



GECO
e-power

pg. 22

pg. 95

SDB JUNIOR

- IT Custodia protettiva per utensili diamantati.
- GB Safe little case for diamond tools.
- ES Caja para herramientas diamantadas.



pg. 88

FSBH Mondrillo **Black-H**

- IT Frese diamantate per foratura a secco.
- GB Diamond core-bits for dry drilling.
- ES Fresas diamantadas par perforación en seco.



pg. 89

FS-TI Mondrillo **Titanium Gold**

- IT Frese diamantate per foratura a secco.
- GB Diamond core-bits for dry drilling.
- ES Fresas diamantadas par perforación en seco.



pg. 102

STL Mondrillo

NEW 20 25

- IT Mole diamantate per taglio, levigatura e lavorazioni speciali.
- GB Diamond cup wheels for cutting, grinding and special processing.
- ES Muelas de diamante para el cortar, rectificar y procesamiento especiales.



pg. 75

JOLLYMONT

- IT Disco diamantato speciale per operazioni di taglio e Jolly.
- GB Diamond blade for cutting and Jolly operations.
- ES Disco de diamante especial para operaciones de corte y Jolly.



pg. 59

SCX-F

NEW 20 25

- IT DNA Sandwich per taglio preciso.
- GB DNA Sandwich for precise cutting.
- ES DNA Sandwich para corte preciso.



TC-HD

NEW 20 25

- IT Turbo sottile per porcellanato alta densità.
- GB Turbo thin for high density porcelain.
- ES Turbo fino para porcelánico de alta densidad.

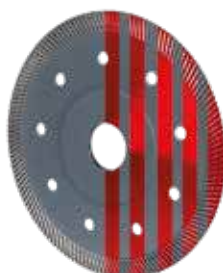

CPJ250

NEW 20 25

- IT Disco diamantato per taglio jolly ad umido.
- GB Diamond blade for wet jolly cutting.
- ES Disco diamantado para Jolly en húmedo.



P5 MASTERPIUMA **POWER**

Tagliapiastrelle manuali SUPER PROFESSIONALI
SUPER PROFESSIONAL manual tile cutters
Cortadoras manuales de baldosas SUPER PROFESIONAL

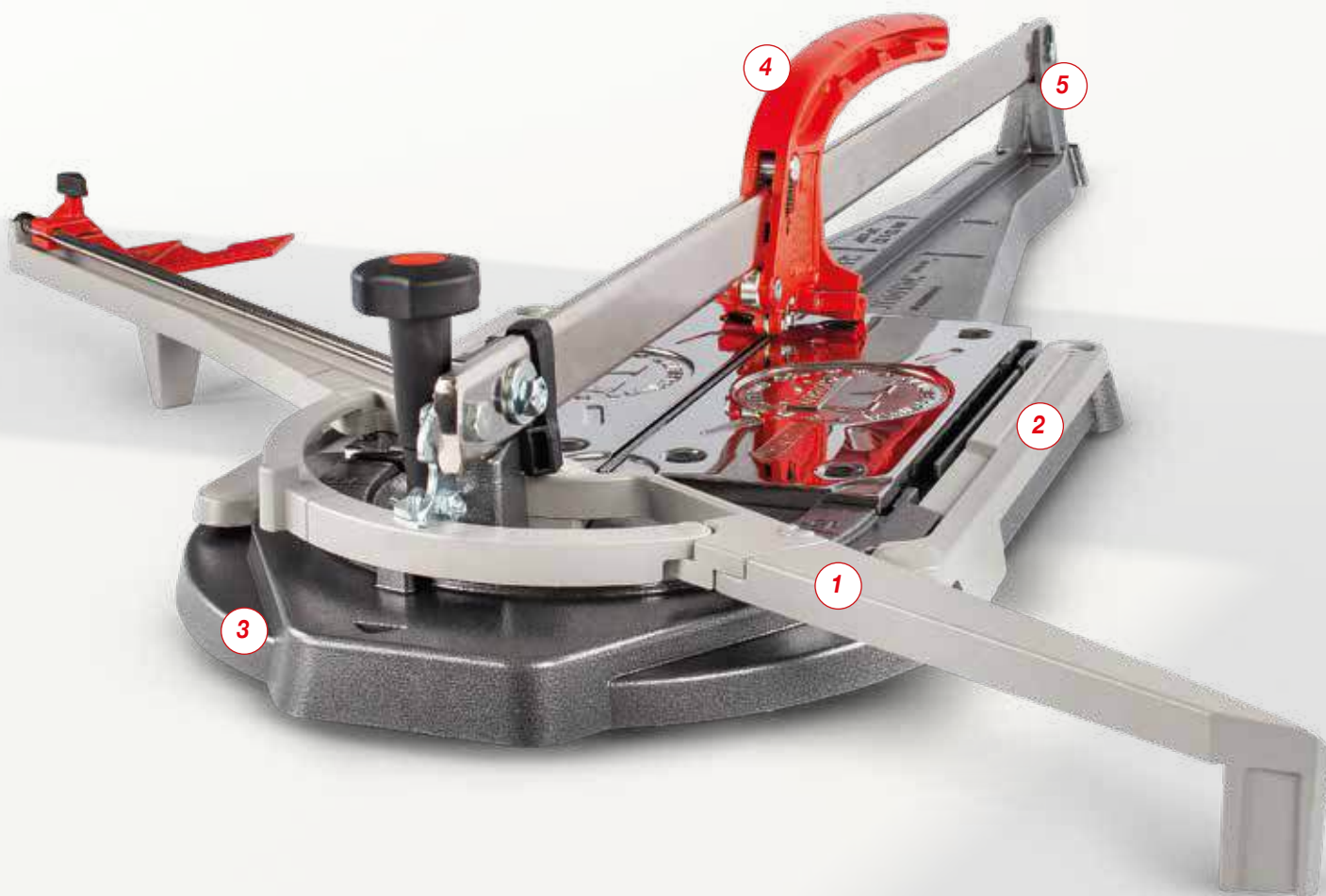

A red banner with a play button icon and the word "Play". Below it are three QR codes and three flags: Italy, UK, and Spain.

5 punti importanti key features puntos importantes



1 Squadra multifunzione
Multi-functional square
Escuadra multifunción

2 Grandi supporti laterali in alluminio
Aluminium extra large supports
Soportes extra grandes de aluminio

3 Telaio modulare strutturato
Reinforced modular frame
Bastidor modular estructurado

4 Indicatori di forza
Strength indicators
Indicadores de fuerza

5 Progettata per grandi formati
Designed for large formats
Diseñada para grandes formatos





MASTERPIUMA



Supporti laterali in alluminio
Aluminium side supports
Soportes laterales en aluminio

F.A.Q.

IT Come posso supportare piastrelle di grande formato?

GB How do I support large format tiles?

ES ¿Cómo apoyo las baldosas de gran formato?



▶ Play



IT Perché la tagliapiastrelle Masterpiuma velocizza il processo di taglio ripetitivo?

GB Why does Masterpiuma tile cutter speed up the cutting process for repetitive cuts?

ES Por qué la cortadora Masterpiuma tile acelera el proceso de corte en cortes repetitivos?



▶ Play



Incisione ergonomica a spinta con indicatori di forza
Ergonomic Push incision with strength indicators
Incidión ergonómica de empuje, con indicadores de fuerza

IT È possibile effettuare tagli laterali molto stretti su piastrelle in gres porcellanato di grande formato?

GB Is it possible to make very narrow side cuts on large format porcelain tiles?

ES ¿Es posible hacer cortes laterales muy estrechos en azulejos de gran formato?



▶ Play



IT È possibile tagliare la ceramica, il mosaico di vetro con questo tagliapiastrelle manuale? E che dire del mosaico in gres per piscine?

GB Is it possible to cut ceramic, glass mosaic with this manual tile cutter? And what's about gresite mosaic for swimming pools?

ES ¿Es posible cortar mosaico de cerámica, vidrio con este cortador manual de azulejos? ¿Y el mosaico de gresite para piscinas?



▶ Play



100% materiale riciclabile
100% recycled material
Material 100% reciclable

Piedoni antiscivolo
Non-slip feet
Pies antideslizantes

Telaio modulare strutturato
Reinforced modular frame
Bastidor modular estructurado



Squadra multifunzione con incisione laser
Multifunctional square with laser engraving
Escuadra multifuncional con grabado láser

Finecorsa elastico
Elastic stop
Parada elástica

Rotazione squadra $-45^\circ \div +45^\circ$
Square rotation $-45^\circ \div +45^\circ$
Rotación de equipo -45° a $+45^\circ$

Squadretta di riferimento ribaltabile
Folding measurement square
Soporte de referencia plegable

Incisione assistita (da 0 a 20mm)
Incision assistance (from 0 to 20 mm)
Incidión asistida (de 0 a 20 mm)

Piani in acciaio molleggiati
Spring metal support tables
Superficies de soporte en acero suspendido

Rotella di incisione a vista titanium gold con guida in acciaio inox
High visibility titanium wheel with stainless steel guide
Rueda de grabado alta visibilidad con guía de acero inoxidable

Lubrificazione integrata
Integrated lubrication
Lubricación integrada

Doppio sistema di spacco con mirino brevettato
Dual splitting device with patented viewfinder
Doble sistema de rotura con visor patentado



	Art.		EURO	63P5	63P5XL	75P5	93P5	131P5	161P5
	245	S/12	7,00	✓	✓	✓	✓	✓	✓
 TITANIUM	245T	S/12	9,00	✓	✓	✓	✓	✓	✓
	505P5	S/1	82,00	✓	✓				
	506P5	S/1	86,00			✓	✓	✓	✓
	507	B/1	20,00	✓	✓	✓	✓	✓	✓
	515-5	B/1	10,00	✓	✓	✓	✓	✓	✓
	428P2	S/1	26,00	✓	✓	✓	✓	✓	✓
	480P5	B/1	19,00	✓					
	481P5	B/1	20,00		✓	✓	✓	✓	✓
	456P5	S/1	99,00	✓	✓	✓	✓		
	457P5	S/1	103,00					✓	✓
	458P5	S/1	30,00	✓	✓	✓	✓		
	459P5	S/1	31,00					✓	✓
	418P5	S/1	37,00	✓					
	418P	S/1	33,00		✓	✓	✓	✓	✓
	519P5	S/1	49,00	✓					
	516P5	S/1	49,00		✓	✓	✓	✓	✓
	281	S/1	12,00	✓	✓	✓	✓		
	281H	S/1	22,00					✓	✓
	440P2	S/1	38,00	✓	✓	✓	✓	✓	✓

Art. 63P5XL		63 cm (24,5 inch)				EURO	
cm	inch	max cm	max inch	kg			
44 x 44	17 x 17	2	3/4	11			384,00

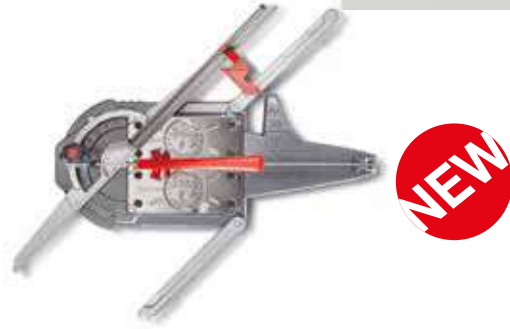

Art. 75P5		75 cm (29 inch)				EURO	
cm	inch	max cm	max inch	kg			
53 x 53	21 x 21	2	3/4	14			428,00



Art. 93P5		93 cm (36 inch)				EURO	
cm	inch	max cm	max inch	kg			
66 x 66	26 x 26	2	3/4	15			478,00

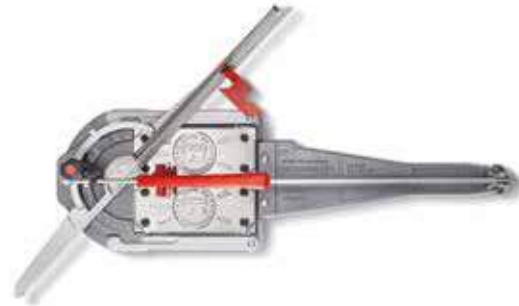

Art. 131P5		131 cm (51,5 inch)				EURO	
cm	inch	max cm	max inch	kg			
92 x 92	36,5 x 36,5	2	3/4	25			748,00

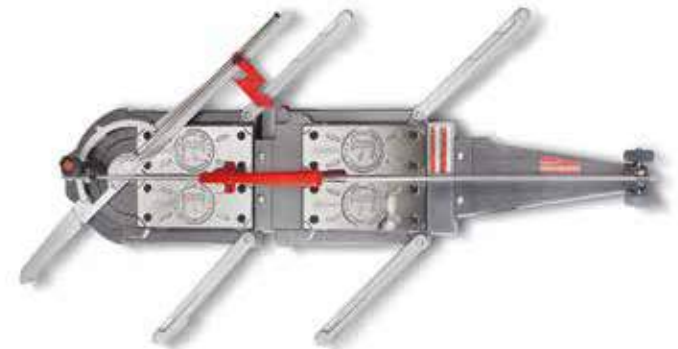

Art. 131P5-TOP						EURO	
cm	inch	max cm	max inch	kg			
							834,00



Include Carapax e Atlas - Carapax and Atlas included - Carapax y Atlas incluidos

Art. 161P5		161 cm (63,5 inch)				EURO	
cm	inch	max cm	max inch	kg			
113 x 113	44,5 x 44,5	2	3/4	29			952,00

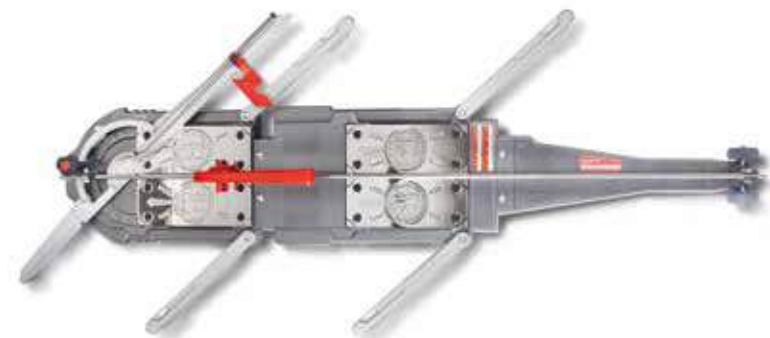

Art. 161P5-TOP						EURO	
cm	inch	max cm	max inch	kg			
							1.038,00



Include Carapax e Atlas - Carapax and Atlas included - Carapax y Atlas incluidos

*Mod. "inch" - Su richiesta - On request - A pedido

MOSAKIT

Art. 58

EURO 49,00

- IT Tappetino in gomma per mosaici, piastrelle in vetro, delicate e sottili (3mm).
- GB Rubber pad for mosaic tiles, delicate and very thin 3mm glass tiles.
- ES Alfombra de goma para mosaicos, baldosas de vidrio, delicadas y finas (3 mm).



BASEBOARD

Art. 64

EURO 56,00

- IT Riferimento aggiuntivo per grandi formati ideale per il taglio di listelli e di battiscopa.
- GB Bracket precision for cutting strip tiles and skirting boards.
- ES Referencia adicional para grandes formatos ideal para el corte de listones y zócalos.

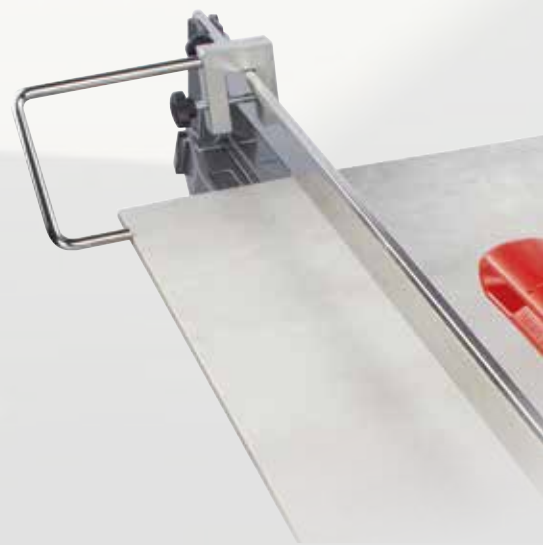
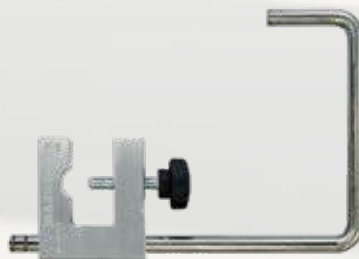

VERTIGO

Art. VERTIGO2

EURO 388,00

- IT Supporto per tagliapiastrelle manuali. Agevola il taglio in verticale delle piastrelle di grande formato.
- GB Support for manual tile cutter, Facilitates the vertical cutting of large format tiles.
- ES Soporte para cortador as de baldosas manuales, Facilita el corte en vertical de las baldosas de gran formato.

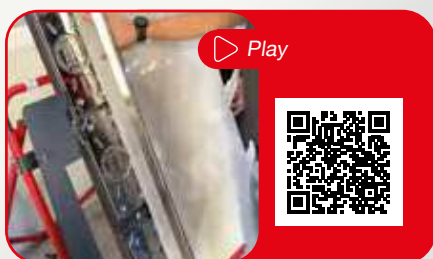

ATLAS



Art. ATLAS

EURO 88,00

- IT Sostegno elastico con doppia regolazione (altezza e peso) per piastrelle di grandi dimensioni utilizzabile con ogni tipo di tagliapiastrelle manuale.
- GB Elastic support with double adjustment (height and weight) for large tiles. Can be used with all types of professional manual tile cutters.
- ES Soporte elástico ajustable para baldosas grandes. Puede utilizarse con cualquier tipo de cortadora manual de baldosas.

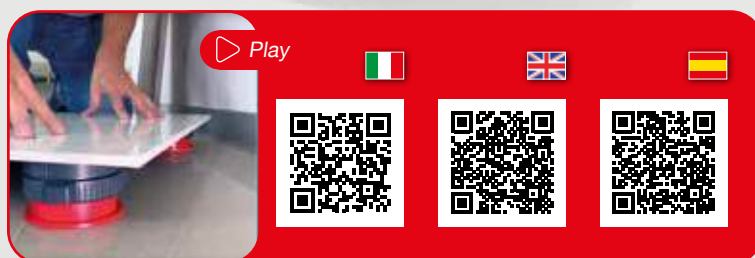

CARAPAX



Art. CARAPAX

EURO 58,00

- IT Protezione elastica per tagliapiastrelle **Masterpiuma P5**
- GB Elastic protection for **Masterpiuma P5** tile cutters.
- ES Protección elástica para cortadoras de baldosas **Masterpiuma P5**.



"Atlas" non inclusi
"Atlas" Not included
"Atlas" No incluido



MASTERPIUMA EVOLUTION 3



Art. 52P3

F.A.Q.

- IT** Qual è il modo migliore per utilizzare la tagliapiastrelle Masterpiuma?
- GB** What is the best way to use the Masterpiuma tile cutter?
- ES** ¿Cuál es la mejor manera de utilizar el cortador de azulejos Masterpiuma?

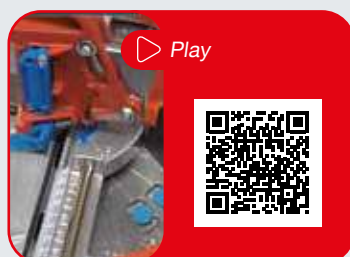

- IT** Come funziona la tagliapiastrelle Masterpiuma su piastrelle con superficie irregolare e strutturata?
- GB** How does the Masterpiuma tile cutter perform on tiles with uneven and textured surface?
- ES** ¿Cómo funciona la cortadora de baldosas con azulejos de superficie irregular?



Art.							kg		EURO
	cm	inch	cm	inch	max cm	max inch			
44P3	44	17	31 x 31	12 x 12	2	3/4	7,7	C/1	282,00
52P3	52	20	37 x 37	14 x 14	2	3/4	8,2	C/1	298,00
63P3	63	25	44 x 44	17 x 17	2	3/4	9,5	C/1	332,00
75P3	75	29	53 x 53	21 x 21	2	3/4	11,8	C/1	394,00
93P3	93	36	66 x 66	26 x 26	2	3/4	13,0	C/1	448,00
125P3	125	49	88 x 88	34,5 x 34,5	2	3/4	24,0	C/1	736,00
155P3	155	61	109 x 109	43 x 43	2	3/4	33,0	C/1	942,00

Accessori | Optionals | Opcionales

MOSAKIT

pg.
10

Art. 58

EURO 49,00

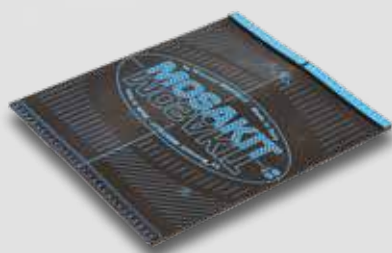

- IT** Tappetino in gomma per mosaici, piastrelle in vetro, delicate e sottili (3mm).
- GB** Rubber pad for mosaic tiles, delicate and very thin 3mm glass tiles.
- ES** Alfombra de goma para mosaicos, baldosas de vidrio, delicadas y finas (3 mm).

BASEBOARD

pg.
10

Art. 64

EURO 56,00

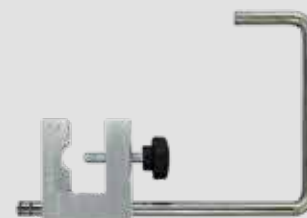





- IT** Riferimento aggiuntivo per grandi formati ideale per il taglio di listelli e di battiscopa.
- GB** Bracket precision for cutting strip tiles and skirting boards.
- ES** Referencia adicional para grandes formatos ideal para el corte de listones y zócalos.

PIUMA BASIC



Art. 63PB

Art.									EURO
	cm	inch	cm	inch	max cm	max inch			
63BP	63	25	44 x 44	17 x 17	2	3/4	8,0	C/1	*
75BP	75	29	53 x 53	21 x 21	2	3/4	9,0	C/1	*
93BP	93	36	66 x 66	26 x 26	2	3/4	10,0	C/1	*
125BP	125	49	88 x 88	34,5 x 34,5	2	3/4	20,0	C/1	*
155BP	155	61	109 x 109	43 x 43	2	3/4	27,5	C/1	*

* Condizioni particolari: contattare Agente di zona e/o ufficio vendite Brevetti MONTOLIT.

* Please call Brevetti MONTOLIT sales department for special sales conditions.

* Condiciones especiales: ponerse en contacto con el oficina de ventas MONTOLIT.

CARAPAX



Art. CARAPAX

EURO 58,00



PIEDONE

Art. 449P

EURO 33,00



IT Protezione elastica per tagliapiastrelle.

GB Elastic protection for tile cutters.

ES Protección elástica para cortadoras de baldosas.

IT Sistema di spacco supplementare.

GB Additional splitting system.

ES Sistema de fractura suplementaria.

MINIMONTOLIT 2

Minimontolit Evolution 2 è una tagliapiastrelle di piccole dimensioni, progettata appositamente per gli utenti fai da te e per lavori meno complicati con piastrelle standard. Questa gamma di macchine consente di tagliare piastrelle di diverso spessore (0-20 mm) e con angoli variabili (0-60°) senza alcuna regolazione.





Minimontolit Evolution 2 is a small dimension tile cutter especially designed for DIY users and less complicated jobs with standard tiles. This range of machines enables you to cut tiles of different thickness (0-20mm) and at varying angles (0-60°) without any adjustment.

Minimontolit Evolution 2 es una cortadora de baldosas de pequeñas dimensiones para usuarios de bricolaje y trabajos menos complicados con baldosas estándar. Esta gama de máquinas le permite cortar baldosas de diferentes espesores (0-20 mm) y en ángulos variables (0-60°) sin ningún ajuste.



Art. 26A2



Art.									EURO
	cm	inch	cm	inch	max cm	max inch			
24	22	8	15 x 15	6 x 6	1,5	1/2	0,6	C/6	45,00
26A2	36	14	25 x 25	10 x 10	2	3/4	2,8	C/6	92,00
43A2	45	18	31 x 31	12 x 12	2	3/4	3,5	C/2	128,00

MINIPIUMA

Questa mini tagliapiastrelle è consigliata sia ai piastrellisti professionisti che agli amanti del fai da te. È particolarmente adatta per l'installazione di piastrelle in grès porcellanato e mosaici in spazi ristretti, dove vengono comunemente installate piastrelle di piccole dimensioni, come cucine e bagni.





This mini tile cutter is suggested for both professional tilers and DIY lovers. It is particularly suitable for the installation of porcelain tiles and mosaic in confined spaces, where small tiles are commonly installed, such as kitchens and bathrooms.



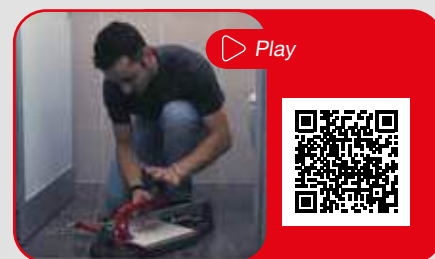



























Este mini cortador de azulejos se recomienda tanto para los colocadores profesionales como para los amantes del bricolaje. Es particularmente adecuado para la instalación de baldosas de porcelánico y mosaicos en espacios reducidos, donde se suelen instalar baldosas pequeñas, como cocinas y baños.



Art. 43PB



Art.									EURO
	cm	inch	cm	inch	max cm	max inch			
26PBox	36	14	25 x 25	10 x 10	2	3/4	5,8	C/2	204,00
43PBox	45	18	31 x 31	12 x 12	2	3/4	6,3	C/2	238,00

				 <p>pg. 14</p>							 <p>pg. 15</p>				 <p>pg. 13</p>				
				MINIMONTOLIT							MINIPIUMA				PIUMA BASIC				
	Art.		EURO	24	26	26A	26A2	43	43A	43A2	26P	26PB	43P	43PB	63PB	75PB	93PB	125PB	155PB
	245	S/12	7,00	✓	✓	✓	✓	✓	✓	✓	✓	✓	✓	✓	✓	✓	✓	✓	✓
 TITANIUM	245T	S/12	9,00	✓	✓	✓	✓	✓	✓	✓	✓	✓	✓	✓	✓	✓	✓	✓	✓
	445BP	S/1	52,00												✓	✓	✓		
	445BP12	S/1	58,00															✓	✓
	264P	S/1	46,00								✓	✓	✓	✓					
	264	S/1	36,00		✓	✓		✓	✓										
	264B	S/1	36,00				✓			✓									
	259	B/1	20,00	✓															
	446P	B/1	16,00												✓	✓	✓	✓	✓
	318	B/1	10,00		✓	✓	✓	✓	✓	✓					✓	✓	✓	✓	✓
	448P	B/1	12,00								✓	✓	✓	✓					
	429P-EVO	S/1	27,00								✓	✓	✓	✓					
	428T	S/1	19,00												✓	✓	✓	✓	✓
	460P	B/1	14,00												✓	✓	✓	✓	✓
	458P	B/1	10,00								✓	✓	✓	✓					
	452P	S/1	55,00								✓	✓	✓	✓					
	454P	S/1	74,00												✓	✓	✓		
	456P	S/1	76,00															✓	✓
	418P	S/1	33,00												✓	✓	✓	✓	✓
	415P	S/1	38,00															✓	✓
	280	S/1	21,00			✓	✓		✓	✓									
	280P	S/1	27,00								✓	✓	✓	✓					
	277	B/1	6,00	✓	✓	✓	✓	✓	✓	✓									
	277P	B/1	10,00								✓	✓	✓	✓					
	281	S/1	12,00												✓	✓	✓		
	281H	S/1	22,00															✓	✓
	440P2	S/1	38,00												✓	✓	✓	✓	✓

																			
				MASTERPIUMA P2								MASTERPIUMA P3							
	Art.		EURO	44P2	52P2	63P2	75P2	93P2	125P2	155P2	44P3	52P3	63P3	75P3	93P3	125P3	155P3		
	245	S/12	7,00	✓	✓	✓	✓	✓	✓	✓	✓	✓	✓	✓	✓	✓	✓		
 TITANIUM	245T	S/12	9,00	✓	✓	✓	✓	✓	✓	✓	✓	✓	✓	✓	✓	✓	✓		
	505	S/1	77,00	✓	✓	✓					✓	✓	✓						
	506	S/1	83,00				✓	✓	✓	✓				✓	✓	✓	✓		
	507	B/1	20,00								✓	✓	✓	✓	✓	✓	✓		
	446P	B/1	16,00	✓	✓	✓	✓	✓	✓	✓									
	318	B/1	10,00	✓	✓	✓	✓	✓	✓	✓									
	515-5	B/1	10,00	✓	✓	✓	✓	✓	✓	✓	✓	✓	✓	✓	✓	✓	✓		
	428P2	S/1	26,00	✓	✓	✓	✓	✓	✓	✓	✓	✓	✓	✓	✓	✓	✓		
	455P2	S/1	89,00	✓	✓						✓	✓							
	456P2	S/1	96,00			✓	✓	✓					✓	✓	✓				
	457P2	S/1	98,00						✓	✓						✓	✓		
	459P	S/1	26,00	✓	✓	✓	✓	✓	✓	✓	✓	✓	✓	✓	✓	✓	✓		
	418P	S/1	33,00	✓	✓	✓	✓	✓	✓	✓	✓	✓	✓	✓	✓	✓	✓		
	415P	S/1	38,00						✓	✓						✓	✓		
	480P2	B/1	15,00	✓	✓						✓	✓							
	481P2	B/1	17,00			✓	✓	✓	✓	✓			✓	✓	✓	✓	✓		
	281	S/1	12,00	✓	✓	✓	✓	✓			✓	✓	✓	✓	✓				
	281H	S/1	22,00						✓	✓						✓	✓		
	440P2	S/1	38,00	✓	✓	✓	✓	✓	✓	✓	✓	✓	✓	✓	✓	✓	✓		

300 PROJECT 300

Tecnologie per la lavorazione delle lastre ceramiche
Technologies for processing ceramic slabs
Tecnologías para el procesamiento de losas cerámica

IT

Sistema per la movimentazione e la lavorazione di piastrelle giganti by Montolit

Le caratteristiche principali da tenere in considerazione nella posa di queste piastrelle sono: dimensione, flessibilità, fragilità e peso.

Il PROGETTO 300 by Montolit comprende una linea di attrezzature espressamente progettata per permettere di affrontare la posa delle lastre con facilità e risultati eccellenti.

ES

Sistema para el desplazamiento y la elaboración de baldosas de grandes dimensiones por Montolit.

Las características principales para considerar en la colocación de estas baldosas son: dimensión, flexibilidad, fragilidad y peso. El PROYECTO 300 por Montolit comprende una línea de equipamiento diseñado exclusivamente para permitir la colocación de las losas con facilidad y resultados excelentes.

GB

System for handling and machining large format tiles by Montolit.

The main features to keep in mind when laying these tiles are: size, flexibility, fragility and weight.

PROJECT 300 by Montolit includes a line of equipment expressly designed to allow for easy installation of slabs with excellent results.

Un sistema completo
A complete system
Un sistema completo



GECO ROBOT

NEW

CE





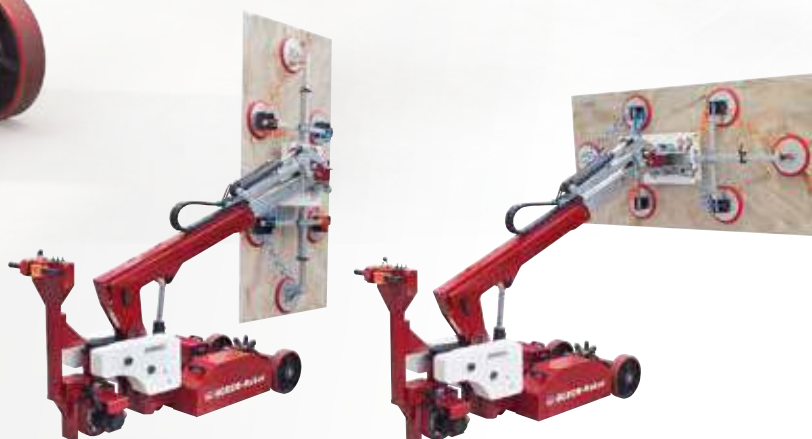

SPECIAL RED RUBBER
NO STAMP

IT Sistema robotizzato a batteria per il sollevamento e la movimentazione delle lastre.

GB Battery powered robotic system for lifting and handling slabs.

ES Sistema robótico a baterías para elevación y manipulación de losas.



							EURO
mt.	kg	mm	kg	kg			
3,25	190 / 485	6 x Ø 300	770	20 x 14 pz	2 x 12V-80A	220x80x120(h) 43kg	*



* Condizioni particolari: contattare Agente di zona e/o ufficio vendite Brevetti MONTOLIT.

* Please call Brevetti MONTOLIT sales department for special sales conditions.

* Condiciones especiales: ponerse en contacto con el oficina de ventas MONTOLIT.

GOAL

- IT Carrello polifunzionale per il trasporto e la lavorazione di lastre.
 GB Multi-purpose bogie for transporting and machining slabs.
 ES Carro multifuncional para el transporte y la elaboración de losas



Pos. 1
 Movimentazione
 Handling
 Desplazamiento



Pos. 2
 Stesura adesivo
 Affixing the adhesive
 Esparcimiento del adhesivo



Art.	cm	kg	kg	C/1	EURO
300-85-EVO	150 x 70 x 150 (h)	28	260	C/1	699,00

LIFTERS

- IT Sollevatori livellanti.
 GB Leveling lifters.
 ES Sistema de elevación y nivelación



Art.	cm	kg	kg	S/1	EURO
LIFTERS	Set 2 pcs.	30	2,95	25	73,00



CORNER

- IT Paraspigoli.
 GB Corner protectors.
 ES Protectores de esquinas.

Art.	mm	inch	Pz./pcs.	B/1	EURO
300-95-04	3 ÷ 4	1/8 ÷ 5/32	Set 4	B/1	15,00
300-95-06	5 ÷ 6	3/16 ÷ 1/4	Set 4	B/1	17,00
300-95-10	8 ÷ 10	5/16 ÷ 3/8	Set 4	B/1	19,00
300-95-12	11 ÷ 12	7/16 ÷ 1/2	Set 4	B/1	21,00

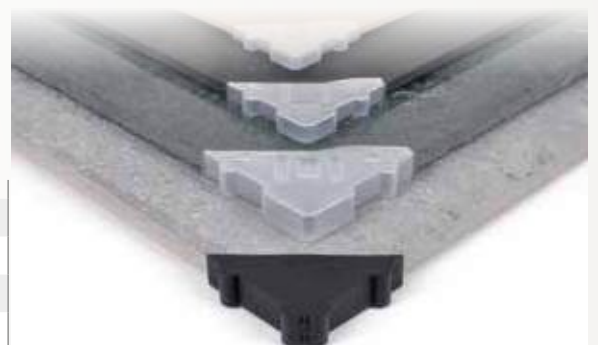

GECO e-power

NEW

CE

SPECIAL RED RUBBER
NO STAMP

NON STOP OPERATION
16 HOURS

ELECTRONIC
CONTROL DISPLAY

- IT Ventosa professionale a batteria.
- GB Professional battery-powered suction cup.
- ES Ventosa profesional a batería.

Batteria ricaricabile
Rechargeable battery
Batería recargable



Art.							EURO
			h	mm	kg	BOX	
GECO E-POWER	3,7VDC -Li-ion 5 Ah- 18Wh	USB · Type-C	6 ÷ 8	200	0,93	S/1	220,00

VT-300

- IT Doppia ventosa per avvicinare e allineare le lastre.
- GB Double suction cup to move close and align slabs.
- ES Doble ventosa para acercar y alinear las losas.

SPECIAL RED RUBBER
NO STAMP



Art.			EURO
	mm	BOX	
VT-300	150	C/1	114,00



GECONE e-power



IT Ventosa super professionale a batteria.
 GB Super professional battery-powered suction cup.
 ES Ventosa super profesional a batería.



SPECIAL RED RUBBER
NO STAMP



2 batterie ricaricabili ed intercambiabili
 2 batteries rechargeable and interchangeable
 2 baterías recargable e intercambiable



Art.							EURO
	N°		h	mm	kg	BOX	
GECONE	2	12VDC -Li-ion 1,5 Ah - 18Wh	2	300 x 160	1,6	S/1	322,00

Display di controllo livello del vuoto
 Vacuum level control display
 Pantalla de control del nivel del vacío

Display di controllo batteria
 Battery control display
 Pantalla de control de la batería



pg. 52 → Ricambi
 Spare parts
 Recambios

LIFT e-power



- IT Barra singola con due ventose.
- GB Single bar with two suction cups.
- ES Barra única con dos ventosas.

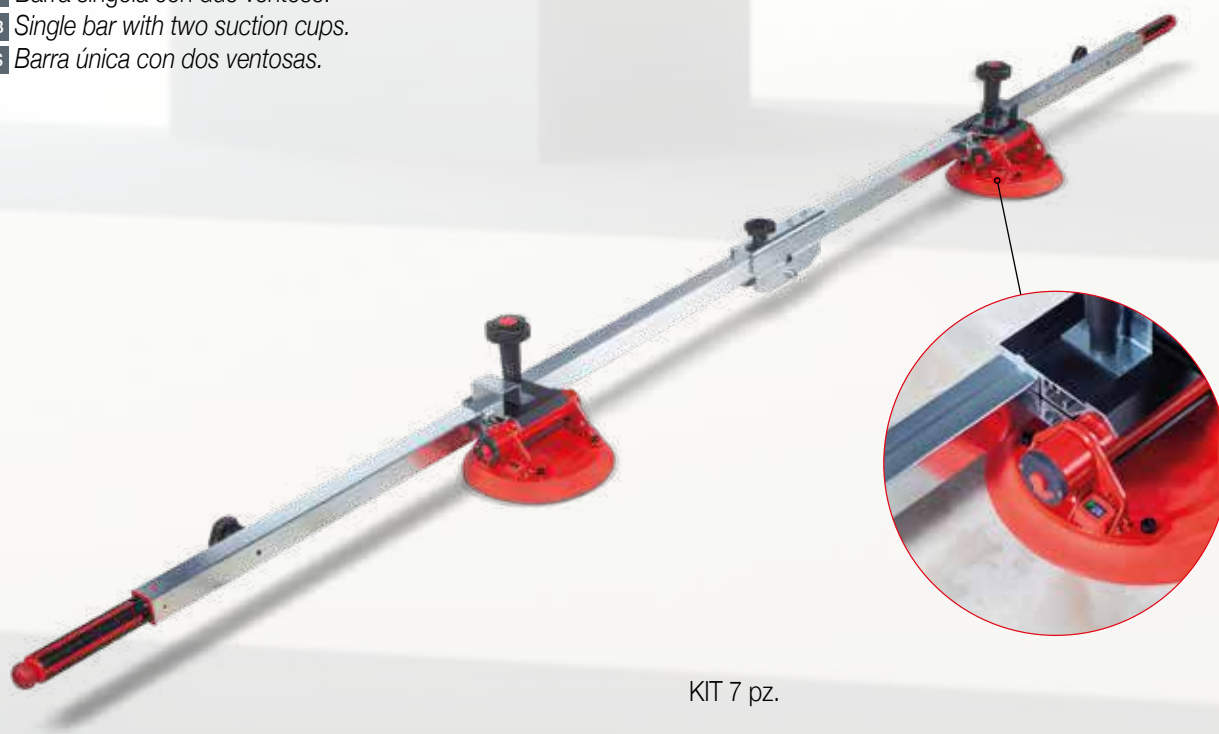

KIT 7 pz.

Art.	kg	BOX	EURO
LIFT e-power	10	C/1	688,00



OPTIONALS Superlift e-power

Art. SUPERLIFT e-power-01
EURO 526,00

- IT Ventosa Extra - 2 pz.
- GB Extra suction cup - 2 pcs.
- ES Ventosa extra - 2 Pz.

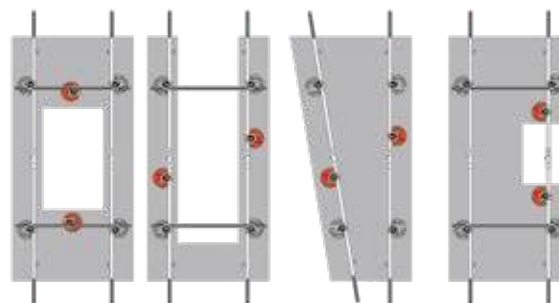
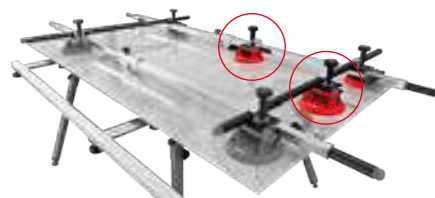

Art. SUPERLIFT e-power-02
EURO 72,00

- IT Sistema di sicurezza per lastre corrugate - 4 pz.
- GB Extra safety hooks for slabs - 4 pcs.
- ES Sistema de seguridad para placas corrugadas - 4 pz.



SUPERLIFT e-power



IT Sistema modulare per la movimentazione di grandi lastre.
 GB Modular handling system for slabs.
 ES Sistema modular de movilización de grande losas.

SPECIAL RED RUBBER
NO STAMP

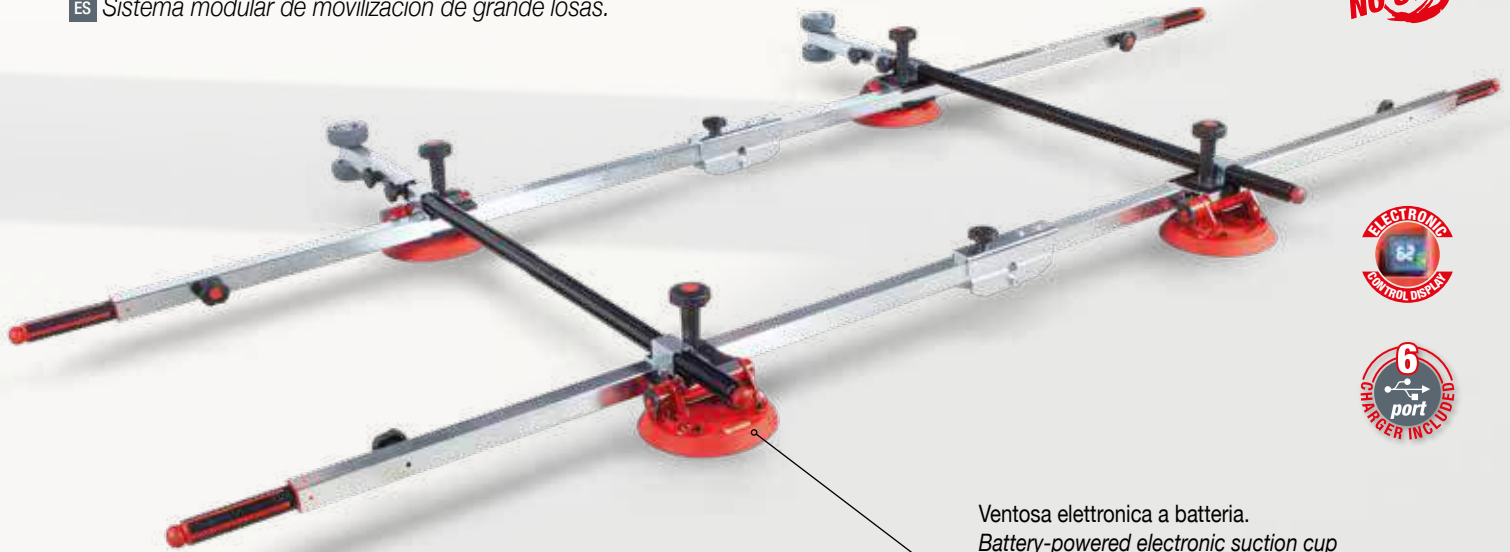

Ventosa elettronica a batteria.
 Battery-powered electronic suction cup
 Ventosa electrónica a batería

KIT 20 pz.



Art.	kg	BOX	EURO
SUPERLIFT e-power	26	C/1	1.588,00

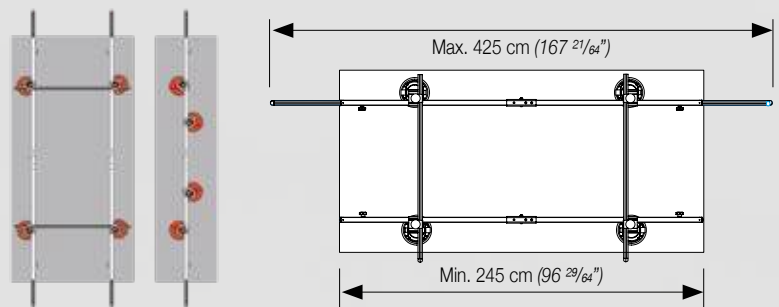

▶ Play

OPTIONAL

Art. 300-20-PLUS

EURO 296,00

- IT Kit prolunga per TABLE-ONE.
- GB Extension kit for TABLE-ONE.
- ES Kit de extensión para TABLE-ONE.

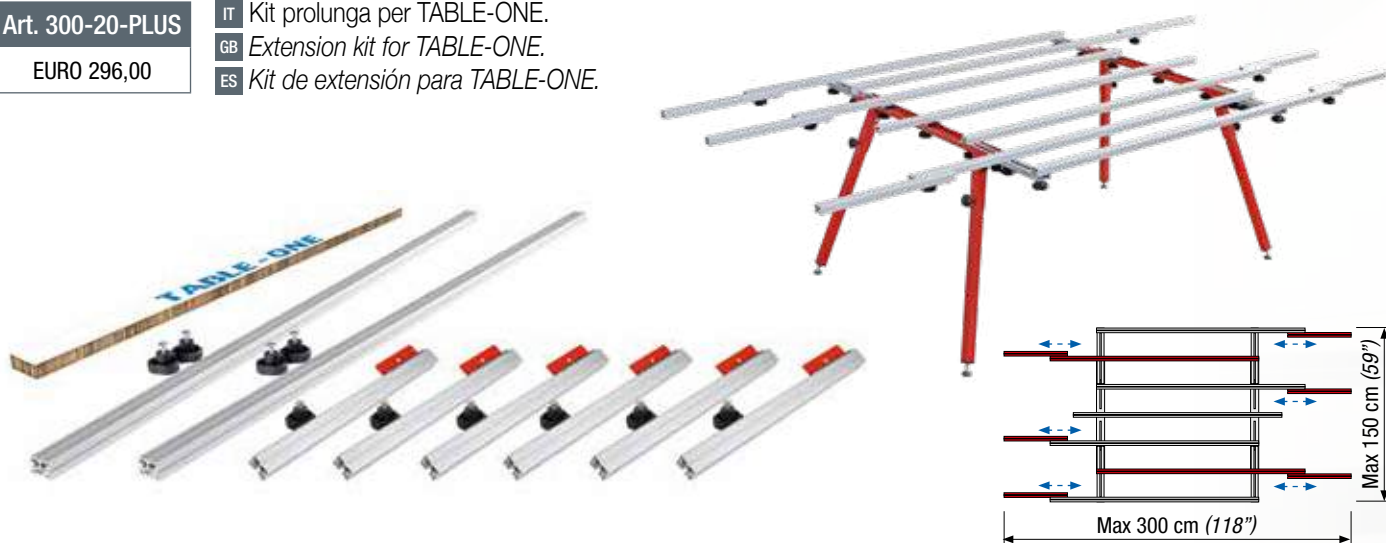

OPTIONAL

Art. 300-25

EURO 81,00

- IT Barra di alluminio extra.
- GB Extra aluminium bar.
- ES Barra extra de aluminio.



Due banchi combinati | Two combined benches | Dos bancos combinados

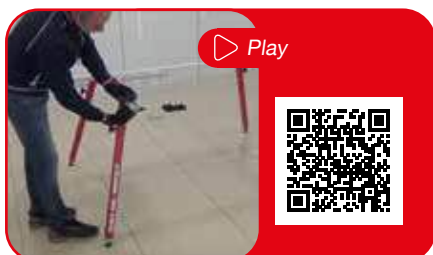
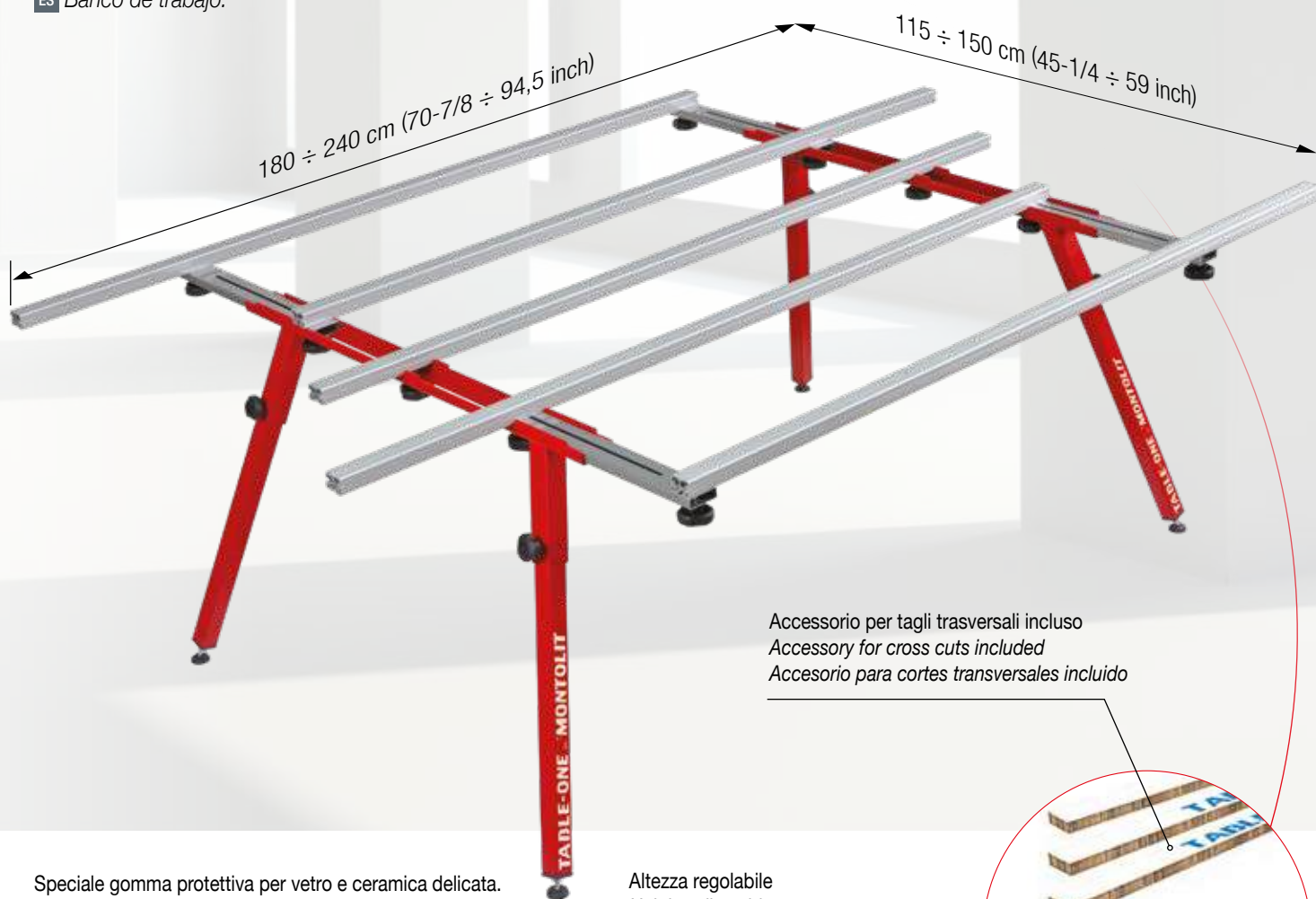

TABLE-ONE



- IT Banco da lavoro.
- GB Work-table.
- ES Banco de trabajo.



Accessorio per tagli trasversali incluso
 Accessory for cross cuts included
 Accesorio para cortes transversales incluido

Speciale gomma protettiva per vetro e ceramica delicata.
 Special anti-slip rubber for glass and soft ceramics
 Goma antideslizante especial para vidrio y cerámica blanda

Altezza regolabile
 Height adjustable
 Altura ajustable

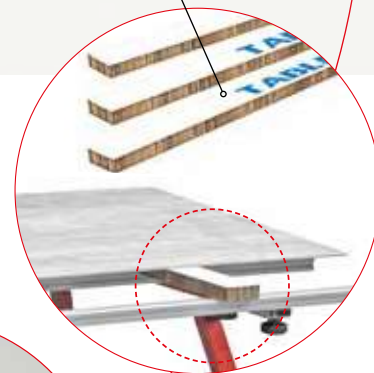
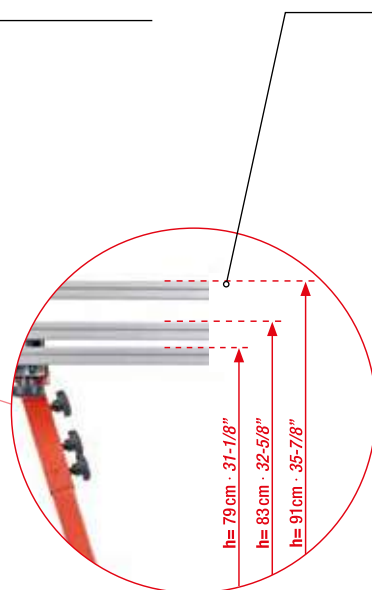
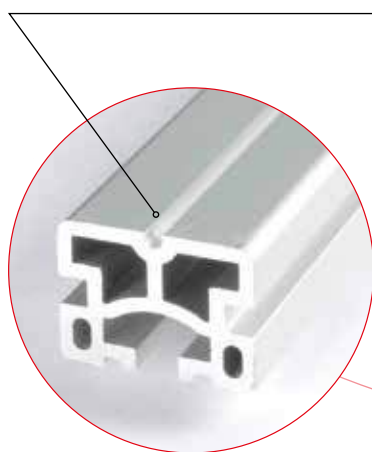

Lunghezza e larghezza regolabili
 Adjustable in length and width
 Ajustable en largo y ancho

Art.	MIN		MAX		kg	BOX	EURO
	cm	inch	cm	inch			
300-20	115 x 180	45-1/4 x 70-7/8	150 x 240	59 x 94-1/2	34	C/1	778,00

FL3 FLASH LINE



La rivoluzione del taglio sul grande formato
The cutting revolution for large format tiles
 La revolución del corte para grandes formatos

Progettata in collaborazione con il Politecnico dell'Università di Milano, permette il taglio manuale di lastre in grès porcellanato di grandi dimensioni fino ad 1 cm di spessore.

Designed in cooperation with the "Politecnico of Milan University", FL3 allow the manual cut of gres porcelain slabs up to 1cm thickness.

Diseñada en colaboración con el Politécnico de la Universidad de Milán, Flash Line FL3, permite el corte manual de placas de gres porcelánico de grandes dimensiones de hasta 1 cm de espesor.

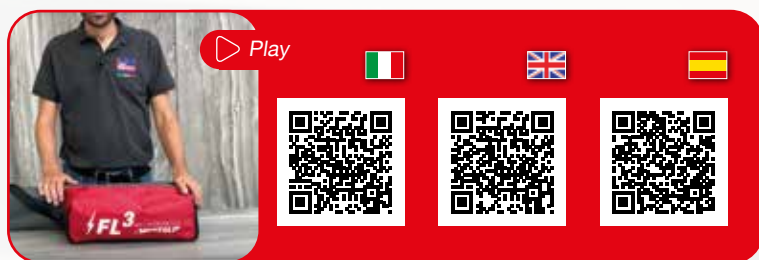

Senza ventose
 Without suction cup
 Sin ventosas



Facile e immediato sistema di selezione delle rotelle in Titanio.
 Titanium wheels selection system. Easy and immediate.
 Sistema de selección de las ruedas de Titanio. Sencillo y rápido.

Art.	cm	inch	max cm	max inch	kg	BOX	EURO
FL3	340	134	1	3/8	8,0	C/1	526,00

Sistema di selezione delle rotelle in Titanio

- 1 Titanium wheels selection system
Sistema de selección de las ruedas de Titanio

Aggancio elastico rapido

- 2 Quick elastic connection
Enganche elástico rápido

Separatore con doppio sistema di spacco

- 3 Double splitting system
Separador con doble sistema de rotura

Ø 20mm (3/4")



Ø 12mm (1/2")

Ø 8mm (5/16")



1



2



3 x 120 cm



3

pg. 47



pg. 108 → Espositore
Display
Expositor

pg. 52 → Ricambi
Spare parts
Recambios

MOTO FLASH LINE 2



CE

Un sistema senza limiti per il taglio a secco

A NO-LIMITS innovative machine







Un sistema para el corte en seco SIN LÍMITES

Evoluzione motorizzata del sistema di taglio manuale Flash line per piastrelle e lastre fino a 4 cm di spessore. La macchina ha in sè tutti i vantaggi di FLASH LINE (facilità di trasporto, leggerezza, precisione, sistema antiscivolo brevettato senza utilizzo di ventose) con l'aggiunta di una testa motorizzata munita di disco diamantato professionale per ceramica e gres porcellanato.

Motorized evolution of manual dry cutting system FLASH LINE. The machine can cut tiles and slabs up to 4 cm (1,5") thickness. The innovative MOTO FLASH LINE includes all the advantages of the Flash Line machine with the addition of a motor power unit complete with a diamond blade dedicated to porcelain and ceramic.

Evolución motorizada del sistema de corte manual Flash line para azulejos y placas de hasta 4 cm de espesor. La máquina dispone de todas las ventajas de FLASH LINE con el añadido de una cabeza motorizada equipada con disco diamantado profesional para cerámica y gres porcelánico.



Art.										EURO
		cm	inch	max cm	max inch	mm	inch			
MFL2-SH	230V~ 1,6kW (2,1HP) 50/60 Hz · 5500 rpm	330	130	2	3/4	150/30	6 / 1-3/16	12,3	C/1	969,00
MFL2-SH-115V	110/120V~ 1,6kW (2,1HP) 50/60 Hz · 5000 rpm	330	130	2	3/4	150/30	6 / 1-3/16	12,8	C/1	997,00
MFL2-SH-PU (Power Unit)	230V~ 1,6kW (2,1HP) 50/60 Hz · 5500 rpm	330	130	2	3/4	150/30	6 / 1-3/16	6,5	C/1	748,00
MFL2-SH-PU-115V (Power Unit)	110/120V~ 1,6kW (2,1HP) 50/60 Hz · 5000 rpm	330	130	2	3/4	150/30	6 / 1-3/16	6,9	C/1	783,00

Collegare ad un aspiratore professionale

- 1 Connect to a professional vacuum cleaner
- Conectar a un aspirador profesional

Art. TCS150MFL

Disco di serie

- 2 Standard blade
- Disco de serie

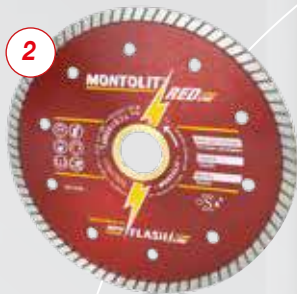

Art. MFL2-SH



Art. MFL2-SH-PU





Massima ergonomia
 Best-in-class ergonomics
 Máxima ergonomía



Art. LPH190MFL



Aspirazione "NO DUST" con regolazione automatica, garantisce l'assenza di polvere ed un raffreddamento ottimale
Self-adjusted vacuum system "no DUST", allows the full dust removal and a perfect cooling.
 Aspiración «NO DUST» con regulación automática, garantiza la ausencia de polvo y una refrigeración óptima.

OPTIONAL

Art. CSS150

EURO 91,00

Disco diamantato supersottile per lastre sottili in grès porcellanato.
Super thin diamond blade for porcelain stoneware slim slabs.
 Disco diamantado súper delgado para losas finas de grés porcelánico.

	Ø 150/30mm Ø 6/1-3/16 inch		3 ÷ 8mm 1/8 ÷ 5/16 inch
---	-------------------------------	---	----------------------------

Massima finitura - velocità ridotta - non forzare
 Clean cut - low speed - don't force while cutting
 Corte limpio - velocidad reducida - No forzar



pg.
70

OPTIONAL

Art. TBH150

EURO 68,00

Disco diamantato per grès porcellanato alto spessore e granito.
Diamond blade for porcelain stoneware high thickness and granite.
 Disco diamantado para grés porcelánico de gran espesor y granito.

	Ø 150/30mm Ø 6/1-3/16 inch		12 ÷ 20mm 1/2 ÷ 3/4 inch
---	-------------------------------	---	-----------------------------

Speciale per Grès porcellanato da 2 cm max
 Special Gres Porcellanato max 2cm
 Especial 2 cm Gres Porcelánico



pg.
74

OPTIONAL

Art. LPH190MFL

EURO 139,00

Disco diamantato per grès porcellanato alto spessore e granito.
Diamond blade for porcelain stoneware high thickness and granite.
 Disco diamantado para grés porcelánico de gran espesor y granito.

	Ø 190/30mm Ø 7,5/1-3/16 inch		20 ÷ 40mm 3/4 ÷ 1-1/2 inch
---	---------------------------------	---	-------------------------------

Speciale per Grès porcellanato da 4 cm max
 Special High Thickness Gres Porcellanato max 4cm
 Especial 4 cm Gres Porcelánico

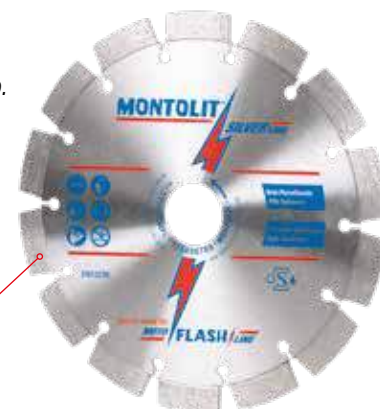



OPTIONAL

Art. MT-H00V

EURO 463,00

Aspiratore professionale per polveri e liquidi.
Professional vacuum cleaner for dust and liquids.
 Aspirador profesional para polvos y líquidos.

	 CAPACITA' BIDONE TANK CAPACITY CAPACIDAD DEL TANQUE	 FLUSSO ARIA MAX AIR FLOW MAX FLUJO DE AIRE MAX	
	L	m ³ /h	kg
230V~/1,2kW	50	166 (45 lt/sec)	11

Ricambi | Spare parts | Ricambios

Art. MT-H00V01

EURO 45,00



Elemento filtrante
 Filter cartridge
 Elemento filtrante

Art. MT-H00V02

EURO 45,00



Sacchetto raccogli-polvere
 Dust collecting bag
 Bolso para recoger el polvo



BATTLE



**SPECIAL RED RUBBER
NO STAMP**

- IT Ventosa battente per piastrelle e lastre.
- GB Thumping suction cup for tiles and slabs.
- ES Ventosa vibradora para baldosas y losas.



pg. 52 → Ricambi
Spare parts
Repuestos

pg. 107 → Espositore
Display
Expositor

Art.			MIN./MAX	\varnothing			EURO
		h	rpm	mm (inch)	kg	BOX	
BATTLE	8,4V -Li-ion 2,5 Ah- 21Wh	2	5.000 ÷ 18.000	120 (4-3/4)	0,95	S/1	210,00

BATTLE PRO

- IT Ventosa battente per piastrelle e lastre.
- GB Thumping suction cup for tiles and slabs.
- ES Ventosa vibradora para baldosas y losas.



3 Velocità
3 Speed
3 velocidades



**SPECIAL RED RUBBER
NO STAMP**



2 batterie 16V 2 Ah
2 battery 16V 2 Ah
2 baterías 16V 2Ah



Art. BTL-P-13 Estensore di vibrazione **INCLUSO**, area interessata più ampia
Art. BTL-P-13 **INCLUDED** Vibration expander, larger area affected
Art. BTL-P-13 **INCLUIDO** Expansor de vibración, mayor área afectada

pg. 52 → Ricambi
Spare parts
Recambios

Art.			MIN./MAX	\varnothing			EURO
		h	rpm	mm (inch)	kg	BOX	
BATTLE-PRO-2B	16V -Li-ion 2 Ah - 32Wh	2,5	5.000 ÷ 12.000	130 (5-1/8)	1,35	S/1	350,00

BATTILONE

IT Ventosa battente per piastrelle e lastre.
 GB Thumping suction cup for tiles and slabs.
 ES Ventosa vibradora para baldosas y losas.



2 batterie 20V 1,5 Ah
 2 battery 20V 1,5 Ah
 2 baterías 20V 1,5 Ah



Art. BTL-P-13 Estensore di vibrazione **INCLUSO**, area interessata più ampia
 Art. BTL-P-13 **INCLUDED** Vibration expander, larger area affected
 Art. BTL-P-13 **INCLUIDO** Expansor de vibración, mayor área afectada

pg. 52 **Ricambi**
Spare parts
Recambios



Art.				MIN./MAX rpm	 mm (inch)			EURO
BATTILONE	2	20V -Li-ion 1,5 Ah - 30Wh	2	4.000 ÷ 7.000	160 (6-5/16)	2,2	S/1	388,00

TOPPROFILE





L'innovativo sistema di PROFILATURA
The innovative PROFILING SYSTEM
 El innovador SISTEMA DE CANTEADO

Sistema di profilatura a secco per piastrelle e lastre, consente di realizzare jolly, biselli, profili raggiati su lastre in gres porcellanato, ceramica e qualsiasi materiale lapideo di ogni dimensione.

Dry profiling system for tiles and slabs, allows for the processing of miter cuts, bevels, radiused profiles on porcelain, ceramic and any stone material of any size.

Sistema de perfilado en seco para baldosas y losas, permite elaborar cortes a inglete, biseles y perfiles redondeados en porcelana, cerámica y cualquier material pétreo de cualquier tamaño.



Art.		 kg	 BOX	EURO
TOPPROFILE	230 V~ · 800 W · 50/60 Hz · 11.000 RPM	4,7	C/1	624,00
TOPPROFILE-115V	110/120 V~ · 900 W · 50/60 Hz · 11.000 RPM	4,7	C/1	633,00

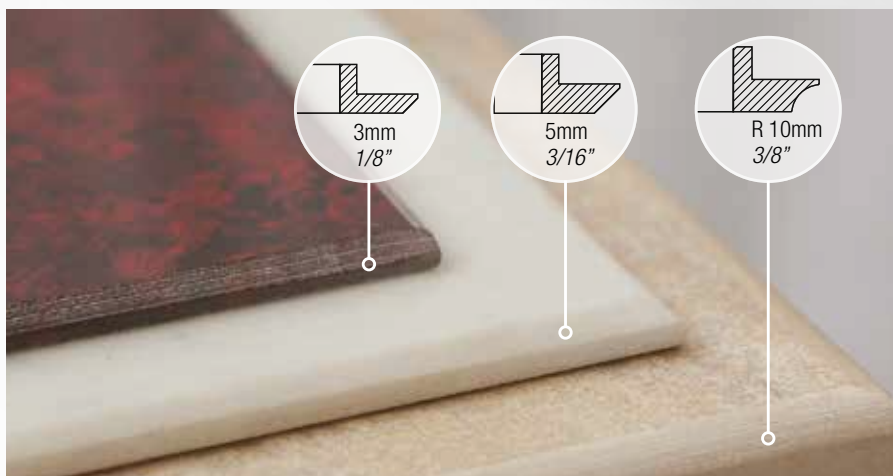

1 Protezione in policarbonato
Polycarbonate protection
Protección de policarbonato

2 Telaio in alluminio
Aluminium frame
Bastidor de aluminio

3 Base in nylon intercambiabile
Interchangeable nylon base
Base de nylon intercambiabile

4 Pratica e robusta borsa in cordura per il trasporto
Practical, sturdy Cordura fabric carrying bag
Bolsa con asas para el transporte

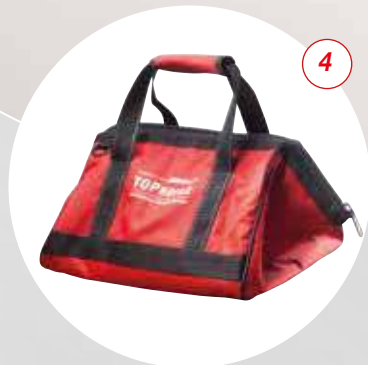
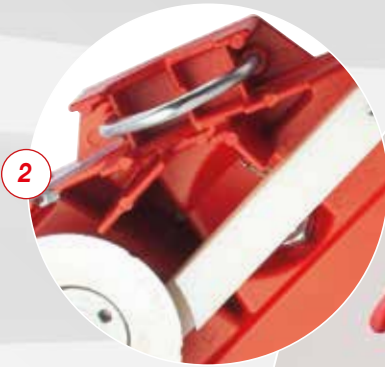

pg.
33

Aspiratore professionale per polveri e liquidi
Professional vacuum cleaner for dust and liquids
Aspirador profesional para polvos y líquidos

**INCLUSO
INCLUDED
INCLUIDO**

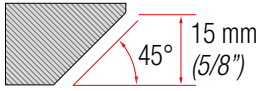

SUPERPROFILE

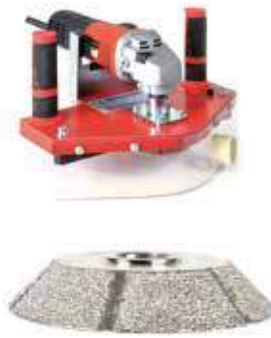

Art. FPE15SP
EURO 190,00

Grana media | *Medium grain* | *Grano medio*

TOPPROFILE



Art. FPE15TP
EURO 190,00

Grana media | *Medium grain* | *Grano medio*

OPTIONAL

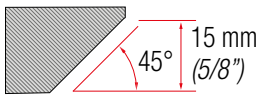

Art. FPE15SPGF
EURO 190,00

Grana fine | *Fine grain* | *Grano fino*



Art. FPE15TPGF
EURO 190,00

Grana fine | *Fine grain* | *Grano fino*

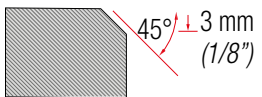

Art. FPE03SP
EURO 145,00



Art. FPE03TP
EURO 145,00

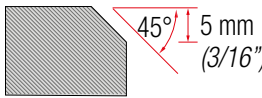

Art. FPE05SP
EURO 157,00



Art. FPE05TP
EURO 157,00

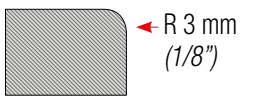

Art. FPB03SP
EURO 147,00



Art. FPB03TP
EURO 147,00

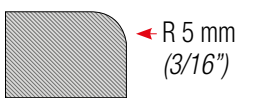

Art. FPB05SP
EURO 157,00



Art. FPB05TP
EURO 157,00

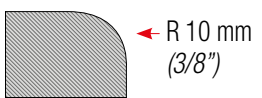

Art. FPB10SP
EURO 180,00



Art. FPB10TP
EURO 180,00

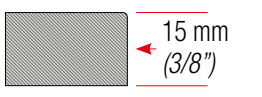

Art. FPZS15SP
EURO 188,00



Art. FPZS15TP
EURO 188,00



Attrezzature elettriche e manuali
Electric and manual equipment
Equipos electricos y manuales



F1 BROOKLYN



IT Taglierina elettrica ad acqua.

GB Electric, water-cooled diamond tile saws.

ES Cortadora eléctrica con agua.

Piani in acciaio inox
Stainless steel work surfaces
Planos de trabajo en acero inoxidable

Motore potente 3hp, disco Ø 250mm
Powerful 3hp engine, blade Ø 250mm
Potente con motor de 3hp, disco de Ø250mm

Art. SCX250
DNA - Disco diamantato incluso
DNA - Diamond blade included
DNA - Disco diamantado incluido

GOLD LINE
"HIGH TECHNOLOGY"



Struttura in alluminio ed acciaio rinforzato
zincato e verniciato
Aluminum frame, reinforced with painted galva-
nized steel
Estructura de aluminio, reforzada con acero
galvanizado pintado.

Squadra goniometrica
Goniometrical square
Escuadra goniométrica

Art. F1-181

Pratica leggera e compatta
Practical, lightweight and compact
Práctica, ligera y compacta



Sistema brevettato per una planarità ottimale (151/181cm)
Patented adjustable legs system (151/181cm)
Sistema de ajuste de altura de patas patentado (151/181cm)

▶ Play

🇮🇹 🇬🇧 🇪🇸

pg. 53 Ricambi
→ Spare parts
Recambios

F1-101

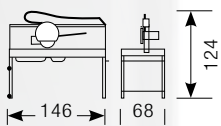

F1-131

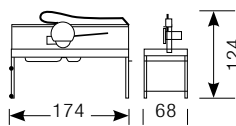



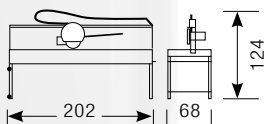

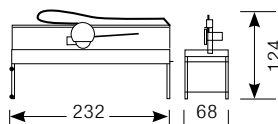

F1-151



F1-181



Art.												EURO
		cm	inch	cm	inch	max cm	max inch	mm	inch			
F1-101	230V~/2,2kW (3HP) 50Hz/2.800rpm	101	40	71 x 71	28 x 28	5	2	250/25,4	10 / 1	75	C/1	2.686,00
F1-131	230V~/2,2kW (3HP) 50Hz/2.800rpm	131	51,5	92 x 92	36 x 36	5	2	250/25,4	10 / 1	85	C/1	2.828,00
F1-151	230V~/2,2kW (3HP) 50Hz/2.800rpm	151	59,5	106 x 106	41,5 x 41,5	5	2	250/25,4	10 / 1	100	C/1	3.362,00
F1-181	230V~/2,2kW (3HP) 50Hz/2.800rpm	181	71,5	128 x 128	50 x 50	5	2	250/25,4	10 / 1	112	C/1	4.049,00
F1-101-115V	115V~/1,5kW (2HP) 60Hz/3.360rpm	101	40	71 x 71	28 x 28	5	2	250/25,4	10 / 1	75	C/1	2.706,00
F1-131-115V	115V~/1,5kW (2HP) 60Hz/3.360rpm	131	51,5	92 x 92	36 x 36	5	2	250/25,4	10 / 1	85	C/1	2.844,00
F1-151-115V	115V~/1,5kW (2HP) 60Hz/3.360rpm	151	59,5	106 x 106	41,5 x 41,5	5	2	250/25,4	10 / 1	100	C/1	3.423,00
F1-181-115V	115V~/1,5kW (2HP) 60Hz/3.360rpm	181	71,5	128 x 128	50 x 50	5	2	250/25,4	10 / 1	112	C/1	4.141,00

OPTIONALS



Art. 58E

EURO 69,00

- IT** Tappetino in gomma per mosaico, piastrelle in vetro, delicate o sottili (3mm).
- GB** Rubber pad for mosaic tiles, delicate and very thin 3mm glass tiles.
- ES** Alfombra de goma para mosaicos, baldosas de vidrio, delicadas y finas (3 mm).



Art. 1051

EURO 190,00

- IT** Tavolino di supporto
- GB** Support table.
- ES** Mesa de soporte



Art. 1305F1

EURO 466,00

Standard su art. F1-181
Standard on art. F1-181
Norma sobre el art. F1-181

- IT** Kit avanzamento con volantino - sistema che fornisce prestazioni di taglio senza sforzo e facile.
- GB** Hand Wheel Feed Kit - a System that provides effortless & easy cutting performance.
- ES** Arrastre con manivela - un sistema que permite cortes fáciles y sin fatiga



Art. 1198F1

EURO 136,00

- IT** Contrasto di precisione per taglio o jolly ripetitivi.
- GB** Precision side square for repetitive cuts or jolly.
- ES** Escuadra lateral de precisión para cortes repetitivos o inglete.

F2

IT Taglierina elettrica ad acqua.
 GB Electric, water-cooled diamond tile saws.
 ES Cortadora eléctrica con agua.



Piano di lavoro in acciaio inox
 Stainless steel worktop
 Plano de trabajo de acero inox

Art. CE
 Disco diamantato incluso
 Diamond blade included
 Disco diamantado incluido

ABS antiurto
 ABS shockproof
 ABS anti impacto



pg. 53 Ricambi
 Spare parts
 Recambios

Art.											EURO
			cm	inch	max cm	max inch	mm	inch			
905EV02	230V~ / 0,45kW (0,6HP) 50Hz / 2.800rpm	Illimitato Unlimited Ilimitado	15 x 15	6 x 6	3,5	1-3/8	180/25,4	7 / 1	7,1	S/1	232,00
906EV02	115V~ / 0,4kW (0,55HP) 50-60Hz / 2.800-3360rpm	Illimitato Unlimited Ilimitado	15 x 15	6 x 6	3,5	1-3/8	180/25,4	7 / 1	7,1	S/1	232,00

BIMBO FORATUTTO



- IT Elettroforatrice ad acqua per frese diamantate.
 GB Electric water-cooled corebit drills.
 ES Perforadora eléctrica con agua para fresadoras diamantadas.



pg. 93 → Frese diamantate non incluse
 → Diamond cutters not included
 Fresadoras diamantada no incluidas

pg. 53 → Ricambi
 → Spare parts
 Recambios











Art.							EURO		
			max mm	max inch	max cm	max inch	kg		
915	230V~ / 0,4kW (0,55HP) 1.400 rpm	M16 Optional: W5/8"	120	4-3/4	3,5	1-3/4	17	C/1	1.352,00
916	115V~ / 0,4kW (0,55HP) 1.400 rpm	M16 Optional: W5/8"	120	4-3/4	3,5	1-3/4	17	C/1	1.372,00

ACCESSORI PER LA FORATURA AD ACQUA

EQUIPMENT FOR WET DRILLING - EQUIPOS PARA LA PERFORACIÓN CON AGUA

Art. PS92	Raccordo portapunta per MU (x artt. 915/916/CVG12) Drill-holder connector for MU (x artt. 915/916/CVG12) Enganche portapunta MU (x artt. 915/916/CVG12)	
EURO 33,00		
Art. AUFA	Raccordo per trapano - M16 (x artt. FA/FAV) Adapter for drill - M16 (x artt. FA/FAV) Adaptador para taladro - M16 (x artt. FA/FAV)	
EURO 19,00		
Art. 88	Mandrino a punta centrale retraente - M16 (x artt. FA/FAV) Arbor with central retractable bit - M16 (x artt. FA/FAV) Mandril con punta central retráctil - M16 (x artt. FA/FAV)	
EURO 72,00		
Art. CVG12	Convogliatore d'acqua completo di tanica Water feed complete with jerry Depósito de agua con bidón	
EURO 160,00		
Art. VTKIT	Ventose per foratura con acqua (Ø 40mm + Ø 60mm) Suction cups for water drilling (Ø 40mm + Ø 60mm) Ventosas para perforación con agua (Ø 40mm + Ø 60mm)	
EURO 53,00		
Art. 89	Riduzione M16 - G 1/2" M16 - G 1/2" adapter Adaptador M16 - G 1/2"	
EURO 21,00		

IT Accessori per foretti diamantati a settori.
 GB Fittings for segmented diamond core-drills.
 ES Accesorios para coronas diamantadas de segmentos.

Art.		ℓ		EURO	
		mm	inch		
AM16F	G 1/2"  M16			31,00	
AM16M	G 1/2"  M16			31,00	
AM16F18	M18  M16			31,00	
MT-AU80	 Ø 12mm  M16 NICHEL-CROMO-MOLIBDENO	80	3-1/4	29,00	
MT-AU230		230	9	38,00	
MT-AS80	 SDS PLUS  M16 NICHEL-CROMO-MOLIBDENO	80	3-1/4	52,00	
MT-AS230		230	9	38,00	
MT-ASMAX	 SDS MAX  M16 NICHEL-CROMO-MOLIBDENO	170	6-11/16	102,00	
M-PC240	attacco conico conical connection conexión cónica  Ø 10mm x artt. M-AU80 · M-AU180 · M-AU280 · M-AS100 · M-AS180 · M-AS280 · M-ASMAX	240	9,5	48,00	
MT-PC220	 x artt. MT-AU80 · MT-AU230 · MT-AS80 · MT-AS230 · MT-ASMAX	220	8-5/8	16,00	
PCFUXL	solo x mod. FUXL e carotatrici mod. EM  only for mod. FUXL and core drills mod. EM Sólo para mod. FUXL y taladradora mod. EM	400	16	132,00	
PCFX	solo x mod. FX e carotatrici mod. EM  only for mod. FX and core drills mod. EM Sólo para mod. FX y taladradora mod. EM	550	21-1/2	123,00	
MT-PR200	 M16  M16 NICHEL-CROMO-MOLIBDENO x mod. FUTS - FUXT	250	10	78,00	
M-PR-W100	con passaggio aspirazione/liquidi  1" 1/4  1" 1/4 with air/fluid gateway con paso de succión/líquido	100	4	101,00	
M-PR-W200		200	8	118,00	
M-PR-W500		500	20	174,00	

CORE EM

- IT Carotatrici professionali con accessori.
- GB Professional core drilling machines with accessories.
- ES Taladradora de diamante profesional con accesorios.



Art. EM18W



Art.				UTILIZZI / USE / USAR			EURO
		max mm	M16		kg	BOX	
EM18W	230V~/1,8kW (2,46HP) 1000/2600 rpm	180	1/2"gas -1-1/4"	+ +	7,3	C/1	1.856,00
EM25W*	230V~/2,5kW (3,35HP) 310/450/960 rpm	250	1/2"gas -1-1/4"		11,5	C/1	3.739,00
EM33W*	230V~/3,3kW (4,49HP) 230/510/730 rpm	350	1/2"gas -1-1/4"		12,5	C/1	4.280,00

* A richiesta - On request - A pedido

- IT Supporto per carotatrici.
- GB Support for core drilling machines.
- ES Soportes para taladros.



Art.							€
		suggested mm	max mm	mm	kg	BOX	
EMB13	0° ÷ 45°	200	250	580	13	C/1	1.258,00
EMB16*	0° ÷ 45°	300	400	610	18	C/1	1.376,00
EMB32*	0° ÷ 45°	350	600	650	19	C/1	2.731,00

* A richiesta - On request - A pedido

CRAB



IT Tenaglia professionale per piastrellista speciale per gres porcellanato.
GB Professional nibbler for porcelain stoneware specifically designed for tilers.
ES Tenaza profesional para soladores especial para gres porcelánico.

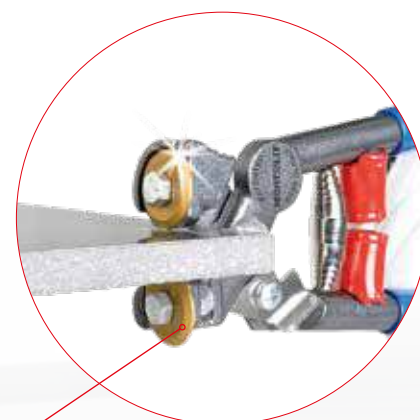
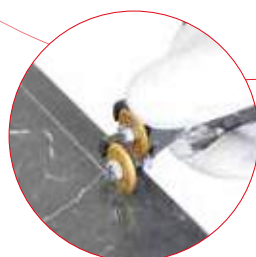

Art.			EURO
33W	g 430	BOX S/6	46,00



[Play](#)





Art. 242TW
EURO 15,00

54

Art. 54
EURO 32,00

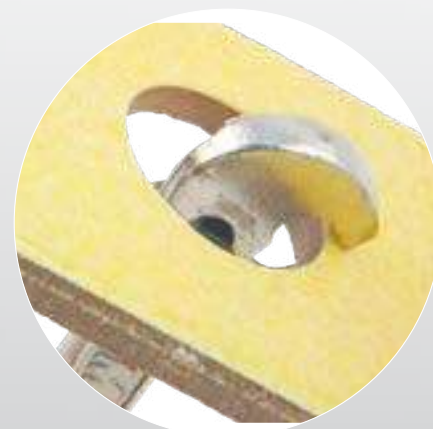
IT Tenaglia per piastrellista a branche incisive regolabili.
GB Tile nibbler with adjustable cutting jaw.
ES Tenaza para solador con dientes incisivos regulables.



MOSAIC



- IT** Tenaglia professionale per mosaico ceramico e vetroso.
- GB** Professional nibbler for ceramic and glass mosaic.
- ES** Tenaza profesional para mosaico de cerámica y vidrio.



Art. 242TW
EURO 15,00

Art.	g	BOX	EURO
55W2	380	S/6	44,00

▶ Play

56RJ

Art. 56RJ
EURO 113,00

- IT** Doppio sistema di spacco Max 15mm.
- GB** Dual splitting system Max 15mm.
- ES** Doble sistema de separación Max 15mm.

56R

Art. 56R
EURO 150,00

- IT** Doppio sistema di spacco Max 20mm.
- GB** Dual splitting system Max 20mm.
- ES** Doble sistema de separación Max 20mm.

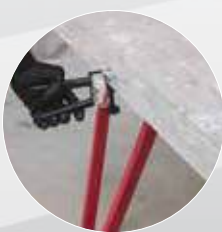



VENTOSA

- IT Ventosa per piastrellista.
 GB Sucker for tile-layer.
 ES Ventosa para montador de baldosas.



SPECIAL RED RUBBER
NO STAMP



Art.	 mm	 kg		EURO
300-76	200	1,250	C/1	190,00

GECO

- IT Ventosa per piastrellista.
 GB Suckers for tile-layer.
 ES Ventosas para montador de baldosas.



SPECIAL RED RUBBER
NO STAMP

Art.	 mm	 kg		EURO
GECO	220	1,100	C/1	110,00

VT80

- IT Ventosa per piastrellista.
 GB Suckers for tile-layer.
 ES Ventosas para montador de baldosas.



Art.	 mm		EURO
VT-80	80	B/1	12,00



MONTHOR



**SPECIAL RED RUBBER
NO STAMP**



- IT** Mazzette in gomma ideali per ogni tipo di ceramica delicata/sottile e gres porcellanato.
- GB** Rubber mallets designed for any kind of thin ceramic and gres porcelain.
- ES** Mazas de goma ideales para todo tipo de cerámica tanto delicada y fina como para porcelánico.

Art.			EURO
MONTHOR500	500	S/4	26,00
MONTHOR1000	1.000	S/4	32,00





▶ Play

16-S

- IT** Sollevalastre per alto spessore e superficie strutturata.
- GB** Handle lift slabs for high thickness and with a structured surfacem.
- ES** Manija de elevación de losas de gran formato, espesor alto y con superficie estructurada.

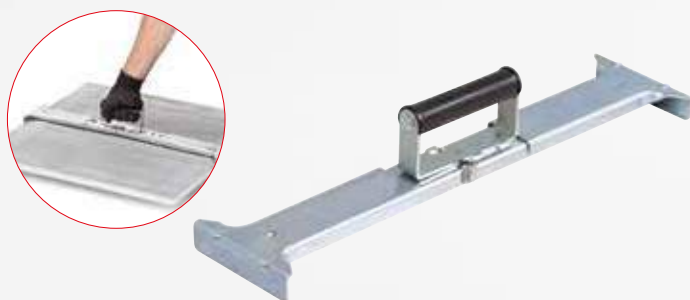

Art.			EURO
16-S	mm 50 ÷ 65 inch. 20 ÷ 25 -3/4	C/2	108,00

25V

- IT** Cutter per vetro/piastrelle/lastre sottili.
- GB** Cutter for glass/ceramic/large formats.
- ES** Cúter para vidrio/baldosas/losas finas.



Art.		EURO
25V	B/1	29,00

MONTHOR 2000

- IT Mazza per blocchi / autobloccanti.
- GB Hammer for blocks and keyblock material.
- ES Martillo para bloques/ autobloqueantes.

Art. MT-24 - EURO 17,00

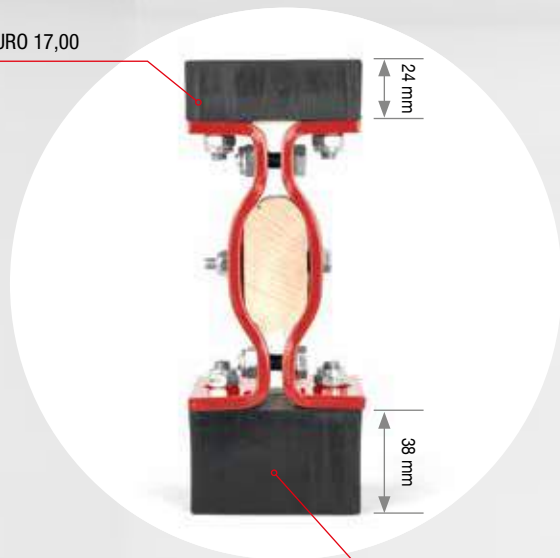





Art. MT-38 - EURO 21,00

Art.	 g	 BOX	EURO
MONTHOR2000	2.000	V/1	67,00

PINZONE

- IT Pinza di sollevamento per cordoli.
- GB Kerb stone handle.
- ES Pinza de elevación para bordillos.



Art.	 mm	 inch.	Portata Max Max load	 g	 BOX	EURO
16	5 ÷ 18	2 ÷ 7 1/2	200	11	C/1	296,00

TAGLIATEGOLE

- IT Tagliategole per tegole in cemento e cotto.
- GB Roof tile cutters for clay roof tiles and concrete.
- ES Cortadora de tejas para tejas de arcilla y hormigón.



Art.	 g	 BOX	EURO
42	7	C/1	282,00





BLOCKUT



- IT Tranciblocchi.
- GB Paving block cutter.
- ES Cortadora de autobloqueantes.



pg. 52 → Ricambi
Spare parts
Recambios



Art.						EURO
	cm inch.	cm inch.		g		
BLOCKUT	33 13	2 ÷ 11 3/4 ÷ 4-3/8	4.100	28	C/1	492,00

X-WORKS

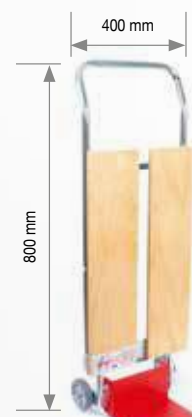
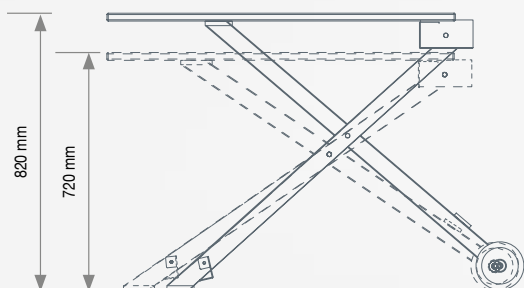

- IT Banco di lavoro per piastrellista.
- GB Work-table for tile installer.
- ES Banco de trabajo para solador.



Art.			EURO
	g		
X-WORKS	18	C/1	342,00

					
	Art.		EURO	FLASH LINE - FL3	BLOCKUT
 Ø 8 mm	240T	B/1	7,00	✓	
 Ø 12 mm	241T	S/12	9,00	✓	
 Ø 20 mm	242T-FL3	B/1	15,00	✓	
	FL3-04	B/1	44,00	✓	
	FL3-03	S/1	171,00	✓	
	56RJ	S/1	113,00	✓	
	300-FL-02	S/1	33,00	✓	
	FL3-02	S/1	33,00	✓	
	FL3-01	S/1	54,00	✓	
	208BC	V/1	115,00		✓
	209BC	V/1	46,00		✓
	302	V/1	10,00		✓

							
	Art.		EURO	BATTILE	BATTILE PRO	BATTILONE	GECONE e-power
	BTL-03	V/1	17,00	✓			
	BTL-P-06	V/1	31,00		✓		
	BATTILONE-02	V/1	13,00			✓	
	BTL-01	S/1	26,00	✓			
	BTL-P-08	S/1	31,00		✓		
	BATTILONE-07	S/1	16,00			✓	
	GECONE-08	V/1	13,00				✓
	BTL-P-04	V/1	73,00		✓		
	BATTILONE-01	V/1	38,00			✓	
	GECONE-01	V/1	28,00				✓
	GECONE-02	V/1	18,00				✓
	GECONE-03	V/1	20,00				✓
	GECONE-04	V/1	20,00				✓
	BTL-02	B/1	11,00	✓			
	BTL-09	V/1	21,00	✓			
	BTL-P-11	V/1	33,00		✓		
	BATTILONE-08	V/1	16,00			✓	
	GECONE-09	V/1	16,00				✓

															
				F1 BROOKLYN								F2		BIMBO FORATUTTO	
	Art.		EURO	F1-101	F1-131	F1-151	F1-181	F1-101-115V	F1-131-115V	F1-151-115V	F1-161-115V	905EV02	906EV02 (115V~)	915	916 (115V~)
	1080MB	V/1	408,00	✓	✓	✓	✓								
	1081MB	V/1	410,00					✓	✓	✓	✓				
	1092EV02	V/1	99,00									✓			
	1093EV02	V/1	99,00										✓		
	1075	V/1	428,00											✓	
	1076	V/1	448,00												✓
	1082	V/1	102,00	✓	✓										
	1082F1	V/1	222,00			✓	✓								
	1083	V/1	103,00					✓	✓						
	1083F1	V/1	278,00							✓	✓				
	1191	V/1	126,00	✓	✓	✓	✓								
	1155	V/1	125,00					✓	✓	✓	✓				
	1096EV02	V/1	29,00									✓			
	1097EV02	V/1	29,00										✓		
	1053	V/1	41,00											✓	
	1054	V/1	43,00												✓
	1077	V/1	190,00											✓	
	1079	V/1	150,00												✓
	1206F1	V/1	124,00	✓	✓	✓	✓	✓	✓	✓	✓				
	1208F1	V/1	62,00	✓	✓	✓	✓	✓	✓	✓	✓				
	1110EV02	V/1	15,00									✓	✓		
	1195	V/1	22,00	✓	✓	✓	✓	✓	✓	✓	✓				
	1095F1SX	V/1	56,00	✓	✓	✓	✓	✓	✓	✓	✓				
	1095F1DX	V/1	56,00	✓	✓	✓	✓	✓	✓	✓	✓				
	1089EV	V/1	104,00	✓	✓			✓	✓						
	1198EV	V/1	98,00			✓	✓				✓	✓			
	1113EV02	V/1	15,00									✓	✓		
	1114EV02	V/1	7,00									✓	✓		
	1073EV	V/1	27,00	✓	✓	✓	✓	✓	✓	✓	✓				
	1201	S/1	27,00	✓	✓	✓	✓	✓	✓	✓	✓				
	302F1	V/1	15,00	✓	✓	✓	✓	✓	✓	✓	✓				
	1072	V/1	56,00											✓	✓

LAMA UNIVERSALE PER LEGNO



- IT Lame circolari universali per legno.
- GB Universal circular blades for timber.
- ES Cuchillas circulares universal para madera.

Art.	Ø		mm	N°	mm	BOX	EURO
	mm	inch					
813	315	12,5	30/25,4	48	3,2	S/1	73,00
814	350	14	35/25,4	54	3,4	S/1	104,00

WOOD CARVER



- IT Lame circolari per legno.
- GB Circular blades for timber.
- ES Cuchillas circulares para madera.

Art.	Ø		mm	N°	BOX	EURO
	mm	inch				
115LL	115	4,5	22,2	6	B/1	34,00
230LL	230	9	22,2	48	B/1	58,00

ATTENZIONE!

Verificare che l'utensile sia compatibile con la macchina sulla quale verrà montato consultandone il manuale d'uso e di sicurezza.

ATTENTION!

Check that this blade is compatible with the machines to which it will be assembled consulting their instructions and safety handbooks.

¡ATENCIÓN!

Comprobar que la herramienta sea compatible con la máquina sobre la cuál será montada consultando el manual de uso y de seguridad.

GRATTINO



- IT Disco per sbavatura e levigatura ideale per cartongesso, legno e plastica.
- GB Disc for grinding suitable for plasterboard, wood and plastic material.
- ES Disco para alisado y pulido ideal para cartón piedra, madera y plástico.

Art.	Ø		mm	BOX	EURO
	mm	inch			
115GL	115	4,5	22,2	B/1	18,00

ATTENZIONE!

Verificare che l'utensile sia compatibile con la macchina sulla quale verrà montato consultandone il manuale d'uso e di sicurezza.

ATTENTION!

Check that this blade is compatible with the machines to which it will be assembled consulting their instructions and safety handbooks.

¡ATENCIÓN!

Comprobar que la herramienta sea compatible con la máquina sobre la cuál será montada consultando el manual de uso y de seguridad.

TUTORCUT-U



IT Guida assistita per tagli perfetti.
 GB Assisted guide for perfect cuts.
 ES Guía asistida para cortes perfectos.



Poliamide antitraccia resistente all'usura.
 Wear-resistant, non-marking polyamide.
 Poliamida que no deja rastro resistente al desgaste.

Adatto alle più comuni smerigliatrici.
 Suitable for the most common grinders.
 Se adapta a las amoladoras más comunes



Rotazioni disco/TutorCut differenziate e indipendenti.
 Differentiated and independent disc/TutorCut rotations.
 Rotaciones del disco/TutorCut diferenciadas e independientes.

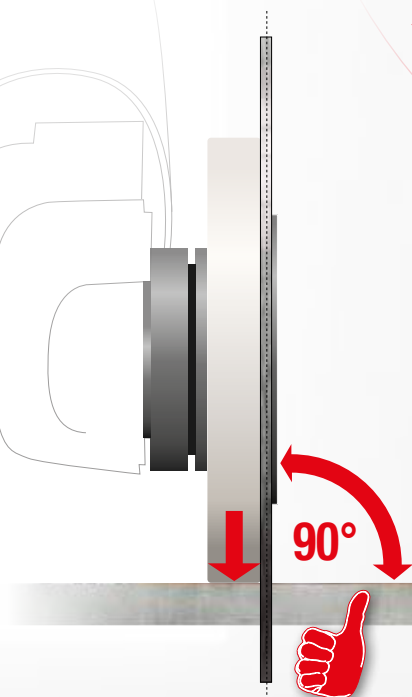

Cuscinetto a sfere ermetico
 Hermetically sealed ball bearing.
 Cojinete de esferas hermético.



Art.	Ø	Ø			BOX	EURO
TUTORCUT115-U	x Ø 115mm	Ø 14mm	20mm	B/1		46,00
TUTORCUT125-U	x Ø 125mm	Ø 14mm	20mm	B/1		48,00
TUTORCUT115-U-16	x Ø 4,5"	Ø 5/8"	3/4"	B/1		46,00
TUTORCUT125-U-16	x Ø 5"	Ø 5/8"	3/4"	B/1		48,00



DNA EVO3

DIAMONDS NETWORK ARRANGEMENT

+100% PERFORMANCE*

+30% SPEED*

+20/50% LIFE*

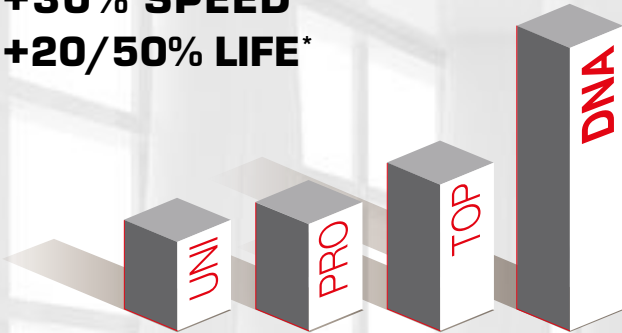

* Test eseguiti su dischi diamantati Brevetti Montolit
* Tests made on Brevetti Montolit diamond tools
* Test realizados en discos diamantados Brevetti Montolit

DNA è una innovativa tecnologia che consiste nella particolare “distribuzione a rete variabile e tridimensionale controllata” dei granuli di diamante contenuti all’interno della parte tagliente degli utensili. Si posizionano le singole grane di diamante a piacimento a secondo del progetto. Con DNA i settori diamantati e comunque tutte le parti taglienti sinterizzate dell’utensile, contenendo la stessa e predefinita quantità di granuli distribuiti con micrometrica precisione, presentano le medesime caratteristiche ottimali espressamente progettate per l’ottenimento delle migliori performances.

DNA Montolit is a revolutionary High Technology system of variable diamond particles that gives the installer the perfect cut every time. The diamonds have been positioned in a Three-dimensional structure which means that when the top layer is worn, the next layer is ready to perform to the same high performance. This is the Montolit DNA standard.

DNA es una innovación tecnológica que consiste en su particular distribución con red variable e tridimensional controlada de los granulos de diamante contenidos en el interior de la parte cortante de las herramientas. Se podrán después “disponer” los granos individuales de diamante a placer según lo proyecto. Con DNA las partes diamantadas y por lo tanto todas aquellas partes cortantes sintetizadas de la herramienta, conteniendo la misma y predefinida cantidad de granulos distribuidos con una precisión micrométrica, presentan las mismas características expresamente proyectadas para la obtención de los mejores resultados.

Particolare distribuzione con reticolo variabile e tridimensionale controllato di granuli di diamante.
Particular distribution with controlled variable and three-dimensional network of diamond granules.
Particular distribución con red variable e tridimensional controlada de los granulos de diamante.



MONTOLIT®

Dischi diamantati
Diamond blades
 Discos diamantados



SCX - SEGMENTS

DNA EVO3

Gres porcellanato/Ceramica "PRO"/Granito
 Porcelain stoneware/Ceramic "Pro"/Granite
 Gres porcelánico/Cerámica "Pro"/Granito

GOLD LINE
 "HIGH TECHNOLOGY"



Velocità - Speed - Velocidad	Durata - Life - Duración	Finitura - Finishing - Acabado
★★★★	★★★★	★★★★☆

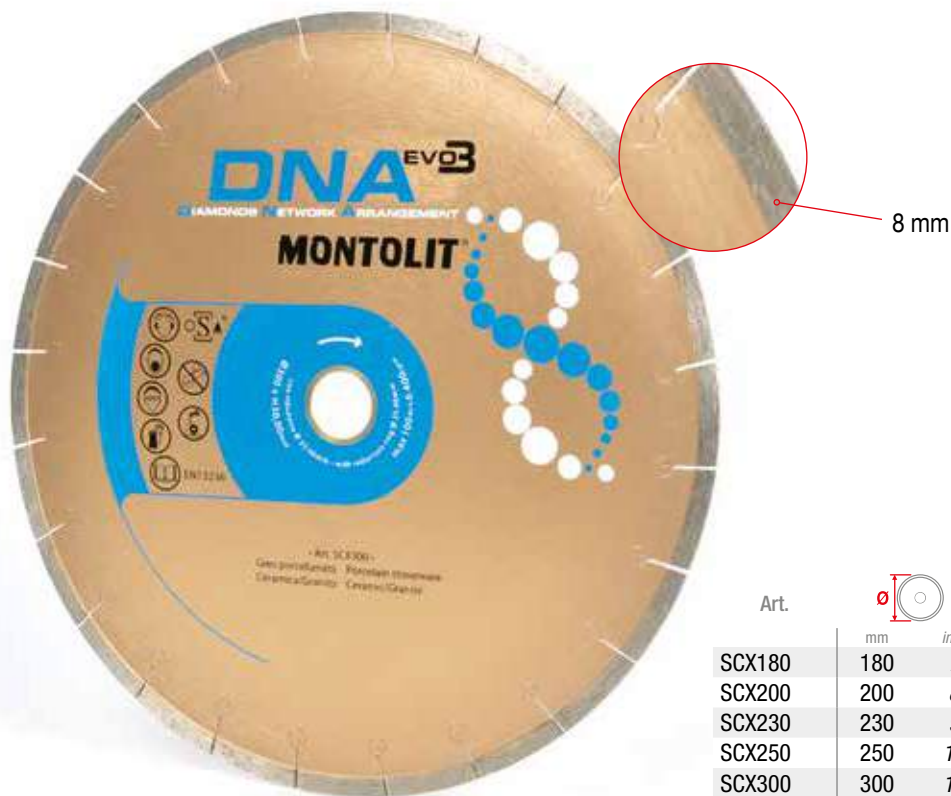

Art.	Ø		Ø		mm	EURO
	mm	inch	mm*	mm		
SCX180	180	7	25,4/22,2	2,0		141,00
SCX200	200	8	30/25,4	2,0		146,00
SCX230	230	9	30/25,4	2,2		164,00
SCX250	250	10	30/25,4	2,2		185,00
SCX300	300	12	30/25,4	2,4		212,00
SCX350	350	14	30/25,4	2,4		276,00
SCX350/60	350	14	60/50	2,4		276,00
SCX400	400	16	60/50	3,2		385,00

* 5/8 inch: Riduzione a richiesta • Reduction on request • Reducción a pedido

IT	GB	ES	
Gres porcellanato	Porcelain stoneware	Gres porcelánico	★★★★★
Piastrelle in monocottura, klinker, cotto	Single-fired ceramic tiles, klinker, terracotta	Baldosas de cerámica, klinker, terracota	★★★★★
Piastrelle in granito e pietre dure	Granite tiles and hard stone	Baldosas de granito y piedras duras	★★★★★
Piastrelle in marmo	Marble tile	Baldosas de mármol	★★★★☆
Piastrelle in bicottura	Double fired glazed tile	Baldosas de doble cocción	★★★☆☆

▶ Play





SCX-S - SEGMENTS

DNA EVO3

Gres porcellanato/Gres porcellanato spessorato/
Granito ceramico
Porcelain stoneware/Porcelain stoneware high thickness/
Ceramic granite
Gres porcelánico/Gres porcelánico de gran espesor/Granito
de cerámica

GOLD LINE
"HIGH TECHNOLOGY"



Velocità - Speed - Velocidad	Durata - Life - Duración	Finitura - Finishing - Acabado
★★★★★	★★★★★	★★★★☆

Art.	Ø		Ø		EURO
	mm	inch	mm *	mm	
SCXS-T200	200	8	30/25,4	2,0	180,00
SCXS-T250	250	10	30/25,4	2,2	220,00
SCXS-T300	300	12	30/25,4	2,4	248,00
SCXS-T350	350	14	30/25,4	2,4	321,00
SCXS-T350/60	350	14	60/50	2,4	321,00
SCXS-T400	400	16	60/50	3,2	432,00

* 5/8 inch: Riduzione a richiesta • Reduction on request • Reducción a pedido

IT	GB	ES	
Gres porcellanato	Porcelain stoneware	Gres porcelánico	★★★★★
Gres porcellanato molto duro	Very hard porcelain stoneware	Gres porcelánico muy duro	★★★★★
Gres porcellanato, monocottura, klinker	Porcelain stoneware, Single-fired ceramic tiles, klinker	Gres porcelánico, monococción, klinker	★★★★★
Piastrelle in granito e pietre dure, cotto	Granite tiles and hard stone, terracotta	Baldosas de granito y piedras duras, terracota	★★★★★
Piastrelle in marmo	Marble tile	Baldosas de mármol	★★★★☆

Speciale per gres porcellanato alto spessore
Special for porcelain stoneware high thickness
Especial para gres porcelánico de alto espesor.

SCX-F - Sandwich Tech

NEW 2025

DNA EVO3

Gres porcellanato/Ceramica/Marmo/Granito
Porcelain stoneware/Ceramic/Marble/Granite
Gres porcelánico/Cerámica/Mármol/Granito

GOLD LINE
"HIGH TECHNOLOGY"



Art.	Ø		Ø		EURO
	mm	inch	mm *	mm	
SCX-F250	250	10	30/25,4	2,2	244,00
SCX-F300	300	12	30/25,4	2,4	274,00
SCX-F350	350	14	30/25,4	2,4	352,00
SCX-F350/60	350	14	60/50	2,4	352,00

* 5/8 inch: Riduzione a richiesta • Reduction on request • Reducción a pedido

Velocità - Speed - Velocidad	Durata - Life - Duración	Finitura - Finishing - Acabado
★★★★★	★★★★☆	★★★★★

IT	GB	ES	
Gres porcellanato	Porcelain stoneware	Gres porcelánico	★★★★★
Gres porcellanato duro	Hard porcelain stoneware	Gres porcelánico duro	★★★★☆
Piastrelle in monocottura, klinker, cotto	Single-fired ceramic tiles, klinker, terracotta	Baldosas de cerámica, klinker, terracota	★★★★★
Piastrelle in granito, pietre dure, marmo	Granite tiles, hard stone and marble	Baldosas de granito, piedras duras y mármol	★★★★★
Piastrelle in bicottura	Double fired glazed tile	Baldosas de doble cocción	★★★★☆

MONTOLIT

CBX - CONTINUOUS RIM

DNA EVO3

Gres porcellanato/Granito
Porcelain stoneware/Granite
Gres porcelánico/Granito



GOLD LINE
"HIGH TECHNOLOGY"



Velocità - Speed - Velocidad	Durata - Life - Duración	Finitura - Finishing - Acabado
★★★★★	★★★★★	★★★★☆

Art.	Ø		Ø		EURO
	mm	inch	mm*	mm	
CBX100 *	100	4	22,2/15,8	1,3	52,00
CBX115 *	115	4,5	22,2	1,3	56,00
CBX125 *	125	5	22,2	1,3	62,00
CBX230	230	9	22,2	2,0	122,00

* 5/8 inch: Riduzione a richiesta • Reduction on request • Reducción a pedido

* **X**LOCK: A richiesta • On request • A pedido

IT	GB	ES	
Gres porcellanato, klinker, monocottura	Porcelain stoneware, klinker, single-fired ceramic	Gres porcelánico, klinker, cerámica	★★★★★
Piastrelle in granito e pietra naturale	Granite tiles and natural stone	Baldosas de granito y piedras naturales	★★★★★
Lastre sottili in gres porcellanato	Porcelain stoneware slim slabs	Losas finas de gres porcelánico	★★★★☆
Gres porcellanato alto spessore	Porcelain stoneware high thickness	Gres porcelánico de alto espesor	★★★★☆
Piastrelle in bicottura, piastrelle in marmo	Double fired glazed tile, marble tile	Baldosas de doble cocción, baldosas de mármol	★★★★☆



TXH - TURBO

DNA EVO3

Granito/Pietre dure/Calcestruzzo/Edilizia/Gres porcellanato spessorato
Granite/Hard stone/Concrete/Building industry/Porcelain stoneware high thickness
Granito/Piedras duras/Hormigón/Construcción/Gres porcelánico de gran espesor



GOLD LINE
"HIGH TECHNOLOGY"



Velocità - Speed - Velocidad	Durata - Life - Duración	Finitura - Finishing - Acabado
★★★★☆	★★★★★	★★★★☆

Art.	Ø		Ø		EURO
	mm	inch	mm*	mm	
TXH115	115	4,5	22,2	2,4	72,00
TXH125	125	5	22,2	2,4	79,00
TXH230	230	9	22,2	2,8	132,00

* 5/8 inch: Riduzione a richiesta • Reduction on request • Reducción a pedido

IT	GB	ES	
Tegole, laterizio, mattoni	Roof tiles, brick	Tejas, ladrillos.	★★★★★
Autobloccanti, arenaria, refrattario	Self-locking bricks, sandstone, refractory	Autobloqueantes, arenisca, refractario	★★★★★
Granito, pietra, porfido	Granite, stone, porphyry	Granito, piedra, pórfido	★★★★★
Gres porcellanato alto spessore	Porcelain stoneware high thickness	Gres porcelánico de alto espesor	★★★★★
Calcestruzzo, calcestruzzo armato	Concrete, reinforced concrete	Hormigón, hormigón armado	★★★★☆
Marmo, ceramica	Marble, ceramic	Mármol, cerámica	★★★★☆



Speciale per gres porcellanato alto spessore
Special for porcelain stoneware high thickness
Especial para gres porcelánico de alto espesor

CGX - CONTINUOUS RIM

DNA EVO3

Gres porcellanato/Ceramica dura
Porcelain stoneware/Hard ceramic
Gres porcelánico/Cerámica dura



GOLD LINE
"HIGH TECHNOLOGY"

Velocità - Speed - Velocidad	Durata - Life - Duración	Finitura - Finishing - Acabado
★★★★	★★★★☆	★★★★☆



Super veloce
Superfast
Súper rápido

Art.	Ø		Ø		EURO
	mm	inch	mm*	mm	
CGX100	100	4	22,2/15,8	1,3	52,00
CGX115	115	4,5	22,2	1,3	56,00
CGX125	125	5	22,2	1,3	62,00

* 5/8 inch: Riduzione a richiesta • Reduction on request • Reducción a pedido

IT	GB	ES	
Gres porcellanato, klinker, monocottura	Porcelain stoneware, klinker, single-fired ceramic	Gres porcelánico, klinker, cerámica	★★★★★
Piastrelle in granito e pietra naturale	Granite tiles and natural stone	Baldosas de granito y piedras naturales	★★★★★
Lastre sottili in gres porcellanato	Porcelain stoneware slim slabs	Losas finas de gres porcelánico	★★★★☆
Gres porcellanato alto spessore	Porcelain stoneware high thickness	Gres porcelánico de alto espesor	★★★★☆
Piastrelle delicate, piastrelle in marmo	Delicate tiles, marble tiles	Delicadas baldosas, baldosas de mármol	★★★★☆



pg. 107 → Espositore
Display
Expositor

LX - LASER

DNA EVO3

Calcestruzzo/Edilizia/Granito/Pietre dure
Concrete/Building Industry/Granite/Porphry/Hard stone
Hormigón/Construcción/Granito/Pórfido/Piedras duras

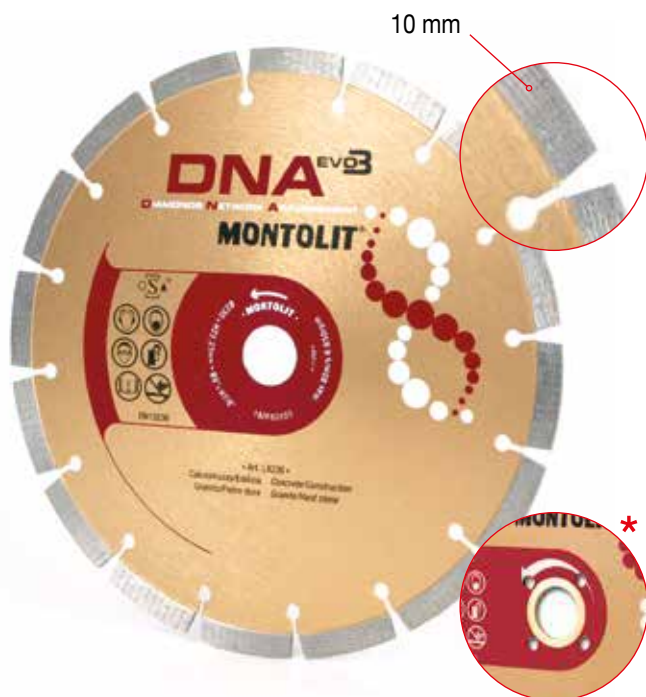

Velocità - Speed - Velocidad	Durata - Life - Duración	Finitura - Finishing - Acabado
★★★★★	★★★★☆	★★★☆☆

Art.	Ø		Ø		EURO
	mm	inch	mm *	mm	
LX115	115	4,5	22,2	2,2	56,00
LX125	125	5	22,2	2,2	61,00
LX150 *	150	6	22,2	2,2	80,00
LX180 *	180	7	22,2	2,2	103,00
LX230	230	9	22,2	2,6	113,00

* 5/8 inch: Riduzione a richiesta • Reduction on request • Reducción a pedido
* Ø 150 e 180 mm - 30/22,2mm: A richiesta • On request • A pedido

IT	GB	ES	
Calcestruzzo, autobloccanti	Concrete, self-locking bricks	Hormigón, autobloqueantes	★★★★★
Calcestruzzo armato	Reinforced concrete	Hormigón armado	★★★★★
Granito, pietra, porfido	Granite, stone, porphyry	Granito, piedra, pórfido	★★★★★
Tegole, laterizio, mattoni	Roof tiles, brick	Tejas, ladrillos.	★★★★★
Arenaria, refrattario	Sandstone, refractory	Arenisca, refractario	★★★★☆

LXS - LASER SILENT

DNA EVO3

Calcestruzzo/Edilizia/Granito/Pietre dure
Concrete/Building Industry/Granite/Porphry/Hard stone
Hormigón/Construcción/Granito/Pórfido/Piedras duras



Velocità - Speed - Velocidad	Durata - Life - Duración	Finitura - Finishing - Acabado
★★★★★	★★★★☆	★★★☆☆

Art.	Ø		Ø		EURO
	mm	inch	mm *	mm	
LXS230	230	9	22,2	2,6	131,00

* 5/8 inch: Riduzione a richiesta • Reduction on request • Reducción a pedido

IT	GB	ES	
Calcestruzzo, autobloccanti	Concrete, self-locking bricks	Hormigón, autobloqueantes	★★★★★
Calcestruzzo armato	Reinforced concrete	Hormigón armado	★★★★★
Granito, pietra, porfido	Granite, stone, porphyry	Granito, piedra, pórfido	★★★★★
Tegole, laterizio, mattoni	Roof tiles, brick	Tejas, ladrillos.	★★★★★
Arenaria, refrattario	Sandstone, refractory	Arenisca, refractario	★★★★☆

LX - LASER

DNA EVO3

Calcestruzzo/Edilizia/Granito/Pietre dure
Concrete/Building Industry/Granite/Porphry/Hard stone
Hormigón/Construcción/Granito/Pórfido/Piedras duras

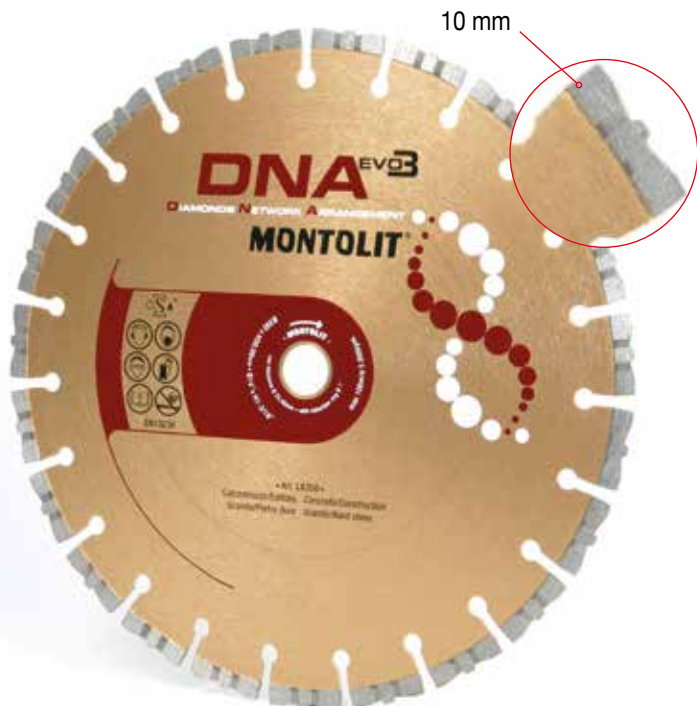

GOLD LINE
"HIGH TECHNOLOGY"

Velocità - Speed - Velocidad	Durata - Life - Duración	Finitura - Finishing - Acabado
★★★★	★★☆☆	★★☆☆

Art.	Ø		Ø		EURO
	mm	inch	mm *	mm	
LX250	250	10	30/25,4	2,6	167,00
LX300	300	12	30/25,4	3,2	242,00
LX350	350	14	30/25,4	3,2	313,00
LX400	400	16	30/25,4	3,2	365,00
LX600	600	24	60/50/25,4	4,0	503,00
LX650	650	26	60/50/25,4	4,0	758,00
LX720	720	29	60/50/25,4	4,0	902,00

* 5/8 inch: Riduzione a richiesta • Reduction on request • Reducción a pedido

IT	GB	ES	
Calcestruzzo armato	Reinforced concrete	Hormigón armado	★★★★
Tegole, laterizio, mattoni	Roof tiles, brick	Tejas, ladrillos.	★★★★
Calcestruzzo, autobloccanti	Concrete, self-locking bricks	Hormigón, autobloqueantes	★★★☆☆
Granito, pietra, porfido	Granite, stone, porphyry	Granito, piedra, pórfido	★★★☆☆
Arenaria, refrattario	Sandstone, refractory	Arenisca, refractario	★★★☆☆

LXS - LASER SILENT

DNA EVO3

Calcestruzzo/Edilizia/Granito/Pietre dure
Concrete/Building Industry/Granite/Porphry/Hard stone
Hormigón/Construcción/Granito/Pórfido/Piedras duras



GOLD LINE
"HIGH TECHNOLOGY"

Velocità - Speed - Velocidad	Durata - Life - Duración	Finitura - Finishing - Acabado
★★★★	★★★☆☆	★★☆☆

Art.	Ø		Ø		EURO
	mm	inch	mm	mm	
LXS350	350	14	30/25,4	3,2	343,00

IT	GB	ES	
Calcestruzzo armato	Reinforced concrete	Hormigón armado	★★★★
Tegole, laterizio, mattoni	Roof tiles, brick	Tejas, ladrillos.	★★★★
Calcestruzzo, autobloccanti	Concrete, self-locking bricks	Hormigón, autobloqueantes	★★★★
Granito, pietra, porfido	Granite, stone, porphyry	Granito, piedra, pórfido	★★★☆☆
Arenaria, refrattario	Sandstone, refractory	Arenisca, refractario	★★★☆☆

MONTOLIT

LXR - LASER

DNA EVO3

Calcestruzzo/Edilizia/Materiali abrasivi/Granito
Concrete/Building industry/Abrasive materials/Granite
Hormigón/Construcción/Materiales abrasivos/Granito



GOLD LINE
"HIGH TECHNOLOGY"

10 mm



Velocità - Speed - Velocidad	Durata - Life - Duración
★★★★	★★★★

Art.	Ø		30/25,4	3,0	EURO
	mm	inch			
LXR300	300	12	30/25,4	3,0	256,00
LXR350	350	14	30/25,4	3,0	332,00
LXR400	400	16	30/25,4	3,0	379,00

IT	GB	ES	
Tegole in cemento, autobloccanti	Concrete roof tiles, self-locking bricks	Tejas de hormigón, autoblocantes	★★★★
Laterizio, mattoni, mattoni abrasivi	Brick, abrasive bricks	Ladrillos, ladrillos abrasivos	★★★★
Arenaria, lastre ghiaino lavato	Sandstone, washed gravel slabs	Arenisca, losas de grava lavada	★★★★
Calcestruzzo, calcestruzzo armato	Concrete, reinforced concrete	Hormigón, hormigón armado	★★★★☆
Granito, pietra, porfido	Granite, stone, porphyry	Granito, piedra, pórfido	★★★☆☆

LXA - LASER

DNA EVO3

Calcestruzzo/Asfalto (Per macchine di bassa/media potenza - max 5kW)
Concrete/Asphalt (For low power machines - max 5kW)
Hormigón/Asfalto (Para máquinas de baja/ media potencia - max 5kW)



GOLD LINE
"HIGH TECHNOLOGY"

10 mm



Velocità - Speed - Velocidad	Durata - Life - Duración
★★★★	★★★★☆

Art.	Ø		30/25,4	3,2	EURO
	mm	inch			
LXA350	350	14	30/25,4	3,2	313,00
LXA400	400	16	30/25,4	3,2	367,00
LXA450	450	18	30/25,4	3,2	436,00

IT	GB	ES	
Asfalto	Asphalt	Asfalto	★★★★
Pavimentazione in calcestruzzo fresco	Green-mixed concrete floor saw	Pavimentos de hormigón fresco	★★★★☆
Pavimentazione in calcestruzzo	Concrete floor saw	Pavimentos de hormigón	★★★☆☆

SX - LASER

DNA EVO3

Pavimenti in calcestruzzo stagionato
Concrete floor saw
Pavimentos de hormigón estacionado



GOLD LINE
"HIGH TECHNOLOGY"

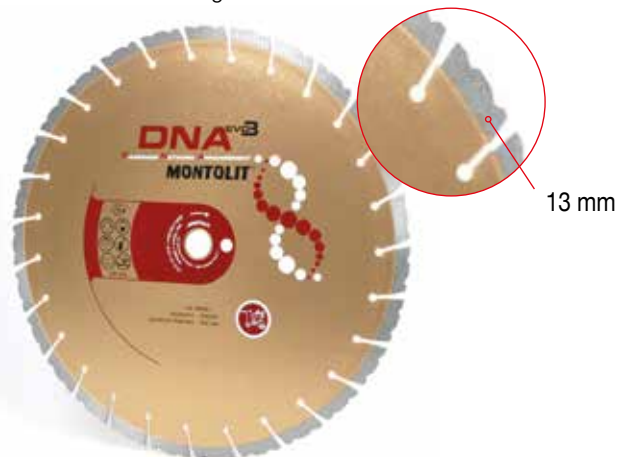

Velocità - Speed - Velocidad	Durata - Life - Duración
★★★★	★★★★

Art.	Ø		Ø		EURO
	mm	inch	mm	mm	
SX350	350	14	30/25,4	2,8	428,00
SX400	400	16	30/25,4	3,2	540,00
SX450	450	18	30/25,4	3,2	595,00
SX500	500	20	30/25,4	4,0	690,00

SXF - LASER

DNA EVO3

Pavimenti in calcestruzzo fresco
Green-mixed concrete floor saw
Pavimentos de hormigón fresco



GOLD LINE
"HIGH TECHNOLOGY"



Velocità - Speed - Velocidad	Durata - Life - Duración
★★★★	★★★★☆

Art.	Ø		Ø		EURO
	mm	inch	mm	mm	
SXF350	350	14	30/25,4	3,2	424,00
SXF400	400	16	30/25,4	3,2	442,00
SXF450	450	18	30/25,4	3,2	469,00

SXA - LASER

DNA EVO3

Asfalto
Asphalt
Asfalto



GOLD LINE
"HIGH TECHNOLOGY"

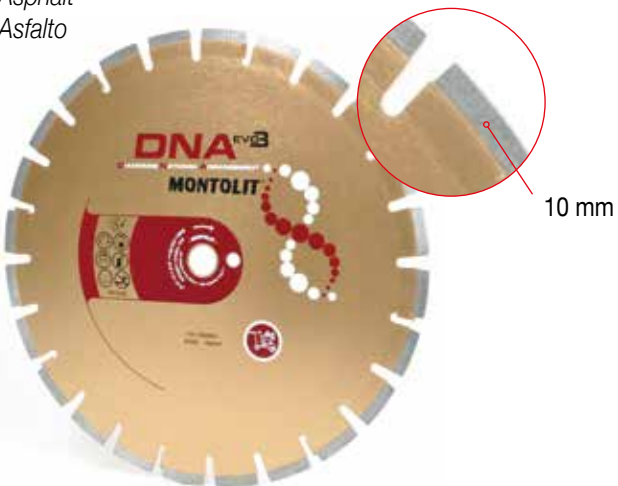

Velocità - Speed - Velocidad	Durata - Life - Duración
★★★★	★★★★☆

Art.	Ø		Ø		EURO
	mm	inch	mm	mm	
SXA400	400	16	30/25,4	3,2	420,00
SXA450	450	18	30/25,4	3,6	510,00
SXA500	500	20	30/25,4	3,6	614,00

MONTOLIT®

Calcestruzzo/Calcestruzzo armato/Materiali edili
Concrete/Reinforced concrete/Building industry
Hormigón/Hormigón armado/Construcción



GOLD LINE
"HIGH TECHNOLOGY"

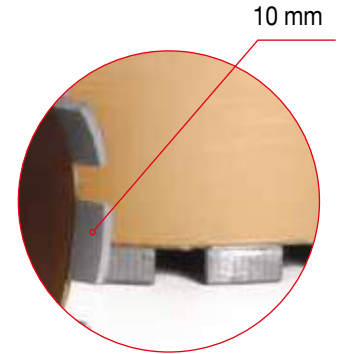

Art.	Ø		n°	mm	n° giri RPM	Potenza consigliata Suggested power Potencia sugerida		EURO
	mm	inch				W min	W max	
FX 32	32	1-1/4	4	450	800 ÷ 1.800	1.200	1.800	147,00
FX 36	36	1-7/16	4	450	700 ÷ 1.700	1.200	1.800	152,00
FX 42	42	1-5/8	5	450	700 ÷ 1.700	1.200	1.800	162,00
FX 47	47	1-7/8	5	450	600 ÷ 1.500	1.200	1.800	178,00
FX 52	52	2-1/16	4	450	500 ÷ 1.300	1.200	1.800	188,00
FX 62	62	2-7/16	5	450	450 ÷ 1.100	1.200	1.800	207,00
FX 82	82	3-1/4	7	450	350 ÷ 800	1.200	2.200	263,00
FX 92	92	3-5/8	7	450	320 ÷ 720	1.200	2.200	283,00
FX102	102	4	8	450	280 ÷ 650	1.200	2.200	300,00
FX112	112	4-7/16	9	450	250 ÷ 600	1.800	2.500	326,00
FX122	122	4-3/4	10	450	230 ÷ 550	1.800	2.500	352,00
FX127	127	5	11	450	230 ÷ 550	1.800	2.500	369,00
FX132	132	5-3/16	11	450	230 ÷ 550	1.800	2.500	387,00
FX142	142	5-5/8	11	450	230 ÷ 550	1.800	2.500	407,00
FX152	152	6	12	450	200 ÷ 500	1.800	2.500	444,00
FX162	162	6-3/8	12	450	180 ÷ 450	1.800	2.500	569,00
FX182	182	7-3/16	14	450	150 ÷ 380	2.000	3.000	644,00
FX202	202	8	15	450	150 ÷ 380	2.000	3.300	830,00
FX225	225	8-7/8	15	450	150 ÷ 380	2.000	3.300	938,00
FX250	250	9-7/8	18	450	150 ÷ 380	2.000	3.300	1.104,00

pg. 44 Accessori
Fittings
Accesorios

VELOCITÀ CONSIGLIATA
RECOMMENDED SPEED
VELOCIDAD RECOMENDADA

Materiale tenero Soft material Material suave	3-4 m/s
Materiale medio Medium material Material mediano	2-3 m/s
Materiale duro Hard material Material duro	1,5-2 m/s

FUXLT TURBO LASER

DNA EVO3

Calcestruzzo/Calcestruzzo armato/Laterizio/Mattoni abrasivi/
Autobloccanti
Concrete/Reinforced concrete/Bricks/Abrasive bricks and
self-blocking
Hormigón/Hormigón armado/Ladrillo/Ladrillos abrasivos y
autobloqueantes



GOLD LINE
"HIGH TECHNOLOGY"

Corpo conico - Massima velocità
Reduced conical body - Max speed
Cuerpo cónico máxima velocidad

Saldatura laser utilizzo a secco
Laser welding dry use
Soldadura láser utilización en seco

DNA SPECIAL TURBO massime prestazioni
SPECIAL TURBO DNA max performance
DNA SPECIAL TURBO máximas prestaciones

10 mm

Attacco 1-1/4" imbocco largo
max asportazione polveri
Thread 1-1/4" large size thread
vacuum dust removal
Conexión 1-1/4" entrada ancha
(máx. Extracción polvos)

Corpo spiralato
rimozione polvere agevolata
Spiral body shape
fast dust removal
Cuerpo de espiral extracción polvo
facilitada



pg. 44 Accessori
Fittings
Accesorios

VELOCITÀ CONSIGLIATA
RECOMMENDED SPEED
VELOCIDAD RECOMENDADA

Materiale tenero Soft material Material suave	3-4 m/s
Materiale medio Medium material Material mediano	2-3 m/s
Materiale duro Hard material Material duro	1,5-2 m/s

Art.	Ø		n°	mm	n° giri RPM	Potenza consigliata Suggested power Potencia sugerida		EURO
	mm	inch				W min	W max	
FUXLT 32	32	1-1/4	3	300	800 ÷ 1.800	1.200	1.800	127,00
FUXLT 42	42	1-5/8	3	300	700 ÷ 1.700	1.200	1.800	148,00
FUXLT 52	52	2-1/16	3	300	500 ÷ 1.300	1.200	1.800	166,00
FUXLT 62	62	2-7/16	3	300	450 ÷ 1.100	1.200	1.800	192,00
FUXLT 68	68	2-11/16	3	300	400 ÷ 900	1.200	2.200	199,00
FUXLT 82	82	3-1/4	4	300	350 ÷ 800	1.200	2.200	208,00
FUXLT102	102	4	5	300	280 ÷ 650	1.200	2.200	243,00
FUXLT112	112	4-7/16	6	300	250 ÷ 600	1.800	2.500	262,00
FUXLT127	127	5	6	300	230 ÷ 550	1.800	2.500	309,00
FUXLT162	162	6-3/8	8	300	180 ÷ 450	1.800	2.500	464,00

FUXT LASER

DNA EVO3

Calcestruzzo/Calcestruzzo armato/Laterizio/Mattoni abrasivi/Autobloccanti
Concrete/Reinforced concrete/Bricks/Abrasive bricks and self-blocking
Hormigón/Hormigón armado/Ladrillo/Ladrillos abrasivos y autobloqueantes



GOLD LINE
"HIGH TECHNOLOGY"

Attacco M16
Thread M16
Conexión M16

Asole speciali rimozione polvere agevolata
Top slots fast dust removal
Ranuras especiales extracción polvo facilitada

Corpo conico massima velocità
Reduced conical body max speed
Cuerpo cónico máxima velocidad

DNA SPECIAL TURBO massime prestazioni
SPECIAL TURBO DNA max performance
DNA SPECIAL TURBO máximas prestaciones

10 mm

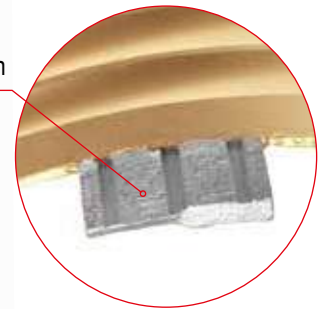

Saldatura laser utilizzo a secco
Laser welding dry use
Soldadura láser utilización en seco

Corpo spiralato
rimozione polvere agevolata
Spiral body shape
fast dust removal
Cuerpo de espiral extracción polvo
facilitada



Art.	Ø		M16	n°	mm	n° giri RPM	Potenza consigliata Suggested power Potencia sugerida		EURO
	mm	inch					W min	W max	
FUXT 32	32	1-1/4	M16	3	150	800 ÷ 1.800	1.200	1.800	98,00
FUXT 36	36	1-7/16	M16	3	150	700 ÷ 1.700	1.200	1.800	101,00
FUXT 42	42	1-5/8	M16	3	150	700 ÷ 1.700	1.200	1.800	107,00
FUXT 47	47	1-7/8	M16	3	150	600 ÷ 1.500	1.200	1.800	121,00
FUXT 52	52	2-1/16	M16	3	150	500 ÷ 1.300	1.200	1.800	126,00
FUXT 57	57	2-1/4	M16	3	150	450 ÷ 1.200	1.200	1.800	131,00
FUXT 62	62	2-7/16	M16	3	150	450 ÷ 1.100	1.200	1.800	136,00
FUXT 68	68	2-11/16	M16	4	150	400 ÷ 900	1.200	2.200	142,00
FUXT 82	82	3-1/4	M16	4	150	350 ÷ 800	1.200	2.200	153,00
FUXT 92	92	3-5/8	M16	4	150	320 ÷ 720	1.200	2.200	175,00
FUXT102	102	4	M16	5	150	280 ÷ 650	1.200	2.200	189,00
FUXT112	112	4-7/16	M16	5	150	250 ÷ 600	1.800	2.500	208,00
FUXT127	127	5	M16	6	150	230 ÷ 550	1.800	2.500	238,00
FUXT132	132	5-3/16	M16	7	150	230 ÷ 550	1.800	2.500	257,00
FUXT142	142	5-5/8	M16	7	150	230 ÷ 550	1.800	2.500	265,00
FUXT152	152	6	M16	7	150	200 ÷ 500	1.800	2.500	284,00
FUXT162	162	6-3/8	M16	8	150	180 ÷ 450	1.800	2.500	323,00
FUXT182	182	7-3/16	M16	9	150	150 ÷ 380	2.000	3.000	354,00
FUXT202	202	8	M16	9	150	150 ÷ 380	2.000	3.000	383,00

pg. 107 → Espositore
Display
Expositor

pg. 44 → Accessori
Fittings
Accesorios

**VELOCITÀ CONSIGLIATA
RECOMMENDED SPEED
VELOCIDAD RECOMENDADA**

Materiale tenero Soft material Material suave	3-4 m/s
Materiale medio Medium material Material mediano	2-3 m/s
Materiale duro Hard material Material duro	1,5-2 m/s

FUTS SPIRAL TURBO

Calcestruzzo/Calcestruzzo armato/Laterizio/Mattoni abrasivi e autobloccanti
 Concrete/Reinforced concrete/Bricks/Abrasive bricks and self-blocking
 Hormigón/Hormigón armado/Ladrillo/Ladrillos abrasivos y autobloqueantes



Attacco M16
 Thread M16
 Conexión M16

Corpo spiralato rimozione
 polvere agevolata
 Spiral body shape fast dust
 removal
 Cuerpo de espiral extracción
 polvo facilitada

12 mm

Asole speciali rimozione
 polvere agevolata
 Top slots fast dust removal
 Ranuras especiales extracción
 polvo facilitada

Saldatura laser utilizzo a secco
 Laser welding dry use
 Soldadura láser utilización en seco



Art.	Ø		n°	mm	n° giri RPM	Potenza consigliata Suggested power Potencia sugerida		EURO
	mm	inch				W min	W max	
FUTS 32	32	1-1/4	M16	3	150	800 ÷ 1.800	1.200 1.800	88,00
FUTS 36	36	1-7/16	M16	3	150	700 ÷ 1.700	1.200 1.800	90,00
FUTS 42	42	1-5/8	M16	3	150	700 ÷ 1.700	1.200 1.800	96,00
FUTS 47	47	1-7/8	M16	3	150	600 ÷ 1.500	1.200 1.800	98,00
FUTS 52	52	2-1/16	M16	3	150	500 ÷ 1.300	1.200 1.800	112,00
FUTS 57	57	2-1/4	M16	3	150	450 ÷ 1.200	1.200 1.800	116,00
FUTS 62	62	2-7/16	M16	3	150	450 ÷ 1.100	1.200 1.800	122,00
FUTS 68	68	2-11/16	M16	4	150	400 ÷ 900	1.200 2.200	125,00
FUTS 82	82	3-1/4	M16	4	150	350 ÷ 800	1.200 2.200	133,00
FUTS 92	92	3-5/8	M16	4	150	320 ÷ 720	1.200 2.200	147,00
FUTS102	102	4	M16	5	150	280 ÷ 650	1.200 2.200	162,00
FUTS112	112	4-7/16	M16	5	150	250 ÷ 600	1.800 2.500	174,00
FUTS127	127	5	M16	6	150	230 ÷ 550	1.800 2.500	199,00
FUTS132	132	5-3/16	M16	6	150	230 ÷ 550	1.800 2.500	204,00
FUTS152	152	6	M16	7	150	200 ÷ 500	1.800 2.500	232,00
FUTS162	162	6-3/8	M16	8	150	180 ÷ 450	1.800 2.500	268,00
FUTS182	182	7-3/16	M16	8	150	150 ÷ 380	2.000 3.000	296,00
FUTS202	202	8	M16	9	150	150 ÷ 380	2.000 3.300	310,00

pg. 44 → Accessori
 Fittings
 Accesorios

VELOCITÀ CONSIGLIATA
 RECOMMENDED SPEED
 VELOCIDAD RECOMENDADA

Materiale tenero Soft material Material suave	3-4 m/s
Materiale medio Medium material Material mediano	2-3 m/s
Materiale duro Hard material Material duro	1,5-2 m/s

CERMONT - CONTINUOUS RIM

Mosaico vetroso e/o in pietra naturale/Ceramica sottile e delicata
 Naturalstone and glass mosaic/Slim and soft ceramic
 Mosaico vidriato y/o en piedra natural/Cerámica fina y delicada



SILVER LINE
"TOP"



Velocità - Speed - Velocidad	Durata - Life - Duración	Finitura - Finishing - Acabado
★★★★☆	★★★★☆	★★★★★

Art.	Ø		Ø		EURO
	mm	inch	mm*	mm	
CM100	100	4	22,2	1,2	48,00
CM115	115	4,5	22,2	1,2	51,00
CM125	125	5	22,2	1,2	53,00

* 5/8 inch: Riduzione a richiesta • Reduction on request • Reducción a pedido

Massima finitura, velocità ridotta, non forzare
 Clean cut, low speed, don't force while cutting
 Corte limpio a baja velocidad, no fuerce mientras corta



IT	GB	ES	
Mosaico vetroso	Glass mosaic	Mosaico de vidrio	★★★★★
Mosaico in gres porcellanato	Porcelain stoneware mosaic	Mosaico de gres porcelánico	★★★★★
Mosaico in pietra naturale	Natural stone mosaic	Mosaico en piedra natural	★★★★★
Lastre sottili in gres porcellanato	Porcelain stoneware slim slabs	Losas finas de gres porcelánico	★★★★★
Piastrelle in bicottura, piastrelle delicate	Double fired glazed tiles, delicate tiles	Baldosas de doble cocción, cerámica delicada	★★★★☆

SLIM CUT - ULTRATHIN

Lastre sottili in gres porcellanato
 Porcelain stoneware slim slabs
 Losas finas de gres porcelánico



SILVER LINE
"TOP"

Velocità - Speed - Velocidad	Durata - Life - Duración	Finitura - Finishing - Acabado
★★★★☆	★★★★☆	★★★★★

ATTENZIONE! USARE ESCLUSIVAMENTE CON TUTORCUT O MOTO FLASH LINE
ATTENTION! USE ONLY WITH TUTORCUT OR MOTO FLASH LINE.
¡ATENCIÓN! UTILICE SOLO CON TUTORCUT O MOTO FLASH LINE.

Art.	Ø		Ø		EURO	
	mm	inch	mm	mm		
CSS100 *	100	4	22,2	1,0	68,00	
CSS150	150	6	30	1,3	91,00	
CSS100-T-U *	N° 1 art. CSS100 + N° 1 art. TUTORCUT115-U					96,00

* 5/8 inch: Riduzione a richiesta • Reduction on request • Reducción a pedido

Special for MOTO FLASH LINE

Massima finitura, velocità ridotta, non forzare!!
 Clean cut, low speed, don't force while cutting
 Corte limpio a baja velocidad, no fuerce mientras corta

IT	GB	ES	
Lastre sottili in gres porcellanato	Porcelain stoneware slim slabs	Losas finas de gres porcelánico	★★★★★
Piastrelle con smalto vetroso	Glass tiles glazed	Baldosas con esmalte vítreo	★★★★★
Piastrelle in bicottura	Double fired glazed tiles	Baldosas de doble cocción	★★★★★
Piastrelle in monocottura	Single-fired ceramic tiles	Baldosas de cerámica	★★★★☆

CG - CONTINUOUS RIM

Gres porcellanato/Ceramica dura
Porcelain stoneware/Hard ceramic
Gres porcelánico/Cerámica dura

10 mm



RED LINE
"PROFESSIONAL"

Velocità - Speed - Velocidad	Durata - Life - Duración	Finitura - Finishing - Acabado
★★★★	★★★★☆	★★★★☆

Art.							EURO
	mm	inch	mm*	mm	mm		
CG115	115	4,5	22,2	1,4		55,00	
CG125	125	5	22,2	1,4		60,00	
CG230	230	9	22,2	2,0		114,00	

* 5/8 inch: Riduzione a richiesta • Reduction on request • Reducción a pedido

IT	GB	ES	
Gres porcellanato, klinker, monocottura	Porcelain stoneware, klinker, single-fired ceramic	Gres porcelánico, klinker, cerámica	★★★★★
Lastre sottili in gres porcellanato	Porcelain stoneware slim slabs	Losas finas de gres porcelánico	★★★★★
Gres porcellanato alto spessore	Porcelain stoneware high thickness	Gres porcelánico de alto espesor	★★★★★
Piastrelle in granito e pietra naturale	Granite tiles and natural stone	Baldosas de granito y piedras naturales	★★★★☆
Piastrelle delicate, piastrelle in marmo	Delicate tiles, marble tile	Delicadas baldosas, baldosas de mármol	★★★★☆

CSE - CONTINUOUS RIM

Ceramica/Gres porcellanato
Ceramic/Porcelain stoneware
Cerámica/Gres porcelánico

8 mm



BLU LINE
"UNIVERSAL"

Velocità - Speed - Velocidad	Durata - Life - Duración	Finitura - Finishing - Acabado
★★★★☆	★★★★☆	★★★★☆

Art.							EURO
	mm	inch	mm*	mm	mm		
CSE115	115	4,5	22,2	1,6		30,00	
CSE230P	230	9	22,2	2,0		92,00	

* 5/8 inch: Riduzione a richiesta • Reduction on request • Reducción a pedido

IT	GB	ES	
Gres porcellanato	Porcelain stoneware	Gres porcelánico	★★★★★
Piastrelle in monocottura, cotto	Single-fired ceramic tiles, terracotta	Baldosas de cerámica, terracota	★★★★★
Piastrelle in granito e pietre naturali	Granite tiles and natural stone	Baldosas de granito y piedras naturales	★★★★☆
Piastrelle in bicottura, piastrelle in marmo	Double fired glazed tiles, marble tiles	Baldosas de doble cocción, baldosas de mármol	★★★★☆
Piastrelle con smalto vetroso	Glass tiles glazed tiles	Baldosas con esmalte vítreo	★★★★☆

TURMONT - CONTINUOUS RIM

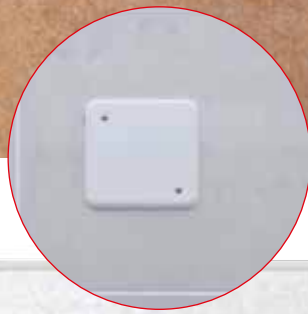

TURMONT - CONTINUOUS RIM

Gres porcellanato/Ceramica dura
 Porcelain stoneware/Hard ceramic
 Gres porcelánico/Cerámica dura



RED LINE
 "PROFESSIONAL"

Velocità - Speed - Velocidad	Durata - Life - Duración	Finitura - Finishing - Acabado
★★★★☆	★★★★☆	★★★★★

Art.	Ø		Ø		EURO
	mm	inch	mm*	mm	
TCS85 *	85	3-3/8	22,2	1,0	33,00

* 5/8 inch: Riduzione a richiesta • Reduction on request • Reducción a pedido

* **XLOCK**: A richiesta • On request • Apedido



Mini disco, ultrasottile
 Mini blade, ultrathin
 Mini disco ultra delgado

IT	GB	ES	
Gres porcellanato	Porcelain stoneware	Gres porcelánico	★★★★★
Lastre sottili in gres porcellanato	Porcelain stoneware slim slabs	Losas finas de gres porcelánico	★★★★☆
Gres porcellanato alto spessore	Porcelain stoneware high thickness	Gres porcelánico de alto espesor	★★★★☆
Piastrelle in granito e pietra naturale	Granite tiles and natural stone	Baldosas de granito y piedras naturales	★★★★☆
Piastrelle delicate, piastrelle in marmo	Delicate tiles, marble tile	Delicadas baldosas, baldosas de mármol	★★★★☆

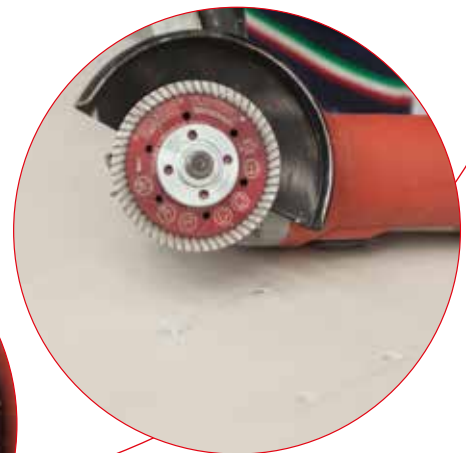

TURMONT - CONTINUOUS RIM

Gres porcellanato/Ceramica dura
Porcelain stoneware/Hard ceramic
Gres porcelánico/Cerámica dura



Velocità - Speed - Velocidad	Durata - Life - Duración	Finitura - Finishing - Acabado
★★★★☆	★★★★☆	★★★★☆

Art.	Ø		Ø		EURO
	mm	inch	mm*	mm	
TCS100R	100	4	22,2/15,8	1,4	44,00
TCS115R *	115	4,5	22,2	1,4	45,00
TCS125R *	125	5	22,2	1,4	48,00
TCS150MFL	150	6	30/22,2	1,4	81,00
TCS250R	250	10	30/25,4	1,65	140,00

8,5 mm

Special for **MOTO FLASH LINE**

* 5/8 inch: Riduzione a richiesta • Reduction on request • Reducción a pedido

* **XLOCK**: A richiesta • On request • Apedido

Rinforzato
Reinforced
Reforzado



Art TCS150MFL

Ultrasottile
Ultrathin
Ultra fino



Art TCS100R

IT	GB	ES	
Gres porcellanato	Porcelain stoneware	Gres porcelánico	★★★★☆
Lastre sottili in gres porcellanato	Porcelain stoneware slim slabs	Losas finas de gres porcelánico	★★★★☆
Gres porcellanato alto spessore	Porcelain stoneware high thickness	Gres porcelánico de alto espesor	★★★★☆
Piastrelle in granito e pietra naturale	Granite tiles and natural stone	Baldosas de granito y piedras naturales	★★★★☆
Piastrelle delicate, piastrelle in marmo	Delicate tiles, marble tile	Delicadas baldosas, baldosas de mármol	★★★★☆

JOLLY MONT - CONTINUOUS RIM



Gres porcellanato/ Gres porcellanato spessorato/
Ceramica/Granito
Porcelain stoneware/ Porcelain stoneware high thickness/
Ceramic/Granit
Gres porcelánico/ Gres porcelánico de gran espesor/
Cerámicas/Granito



SILVER LINE
"TOP"

Velocità - Speed - Velocidad	Durata - Life - Duración	Finitura - Finishing - Acabado
★★★★☆	★★★★★	★★★★☆

Art.					EURO
	mm	inch	mm*	mm	
CJ115	115	4,5	22,2	1,6	62,00
CJ125	125	5	22,2	1,6	69,00

* 5/8 inch: Riduzione a richiesta • Reduction on request • Reducción a pedido

25 mm
FULL DIAMOND



Speciale per Jolly
Special for Jolly
Especial para Jolly



IT	GB	ES	
Gres porcellanato, klinker	Porcelain stoneware, klinker	Gres porcelánico, klinker	★★★★★
Gres porcellanato alto spessore	Porcelain stoneware high thickness	Gres porcelánico de alto espesor	★★★★★
Piastrelle in monocottura, cotto	Single-fired ceramic tiles, terracotta	Cerámica, terracota	★★★★★
Piastrelle in granito e pietra naturale	Granite tiles and natural stone	Baldosas de granito y piedras naturales	★★★★★
Lastre sottili in gres porcellanato	Porcelain stoneware slim slabs	Losas finas de gres porcelánico	★★★★☆



CERMONT - CONTINUOUS RIM

Informazioni rapide:

- Progettato specificamente per il taglio a umido di ogni piastrella di vetro e mosaico di vetro.
- La lama per il taglio del vetro più veloce e pulita del settore
- Riduce drasticamente gli scarti
- Prestazioni eccellenti durante il taglio di angoli a 45° o acuti.
- La finitura di alta qualità fornisce tagli simili a quelli di fabbrica.
- Maggiore durata della lama rispetto alle comuni lame per vetro.
- Risparmia tempo ottenendo risultati perfetti!

Quick facts:

- Designed specifically for wet cutting every glass tile and glass mosaic.
- The fastest and cleanest glass cutting blade in the industry
- Drastically reduces of the waste
- Top performance while cutting 45° or sharp corners.
- High quality finish provides factory like cuts.
- Longer blade life compared to common glass blades.
- Save your time obtaining perfect results!

Datos rápidos:

- Diseñado específicamente para el corte en húmedo de todas las baldosas de vidrio y vidrio mosaico.
- La cuchilla de corte de vidrio más rápida y limpia de la industria
- Reduce drásticamente los residuos
- Máximo rendimiento al cortar esquinas de 45° o afiladas.
- El acabado de alta calidad proporciona cortes similares a los de fábrica.
- Mayor vida útil de la hoja en comparación con las cuchillas de vidrio comunes.
- ¡Ahorre tiempo obteniendo resultados perfectos!

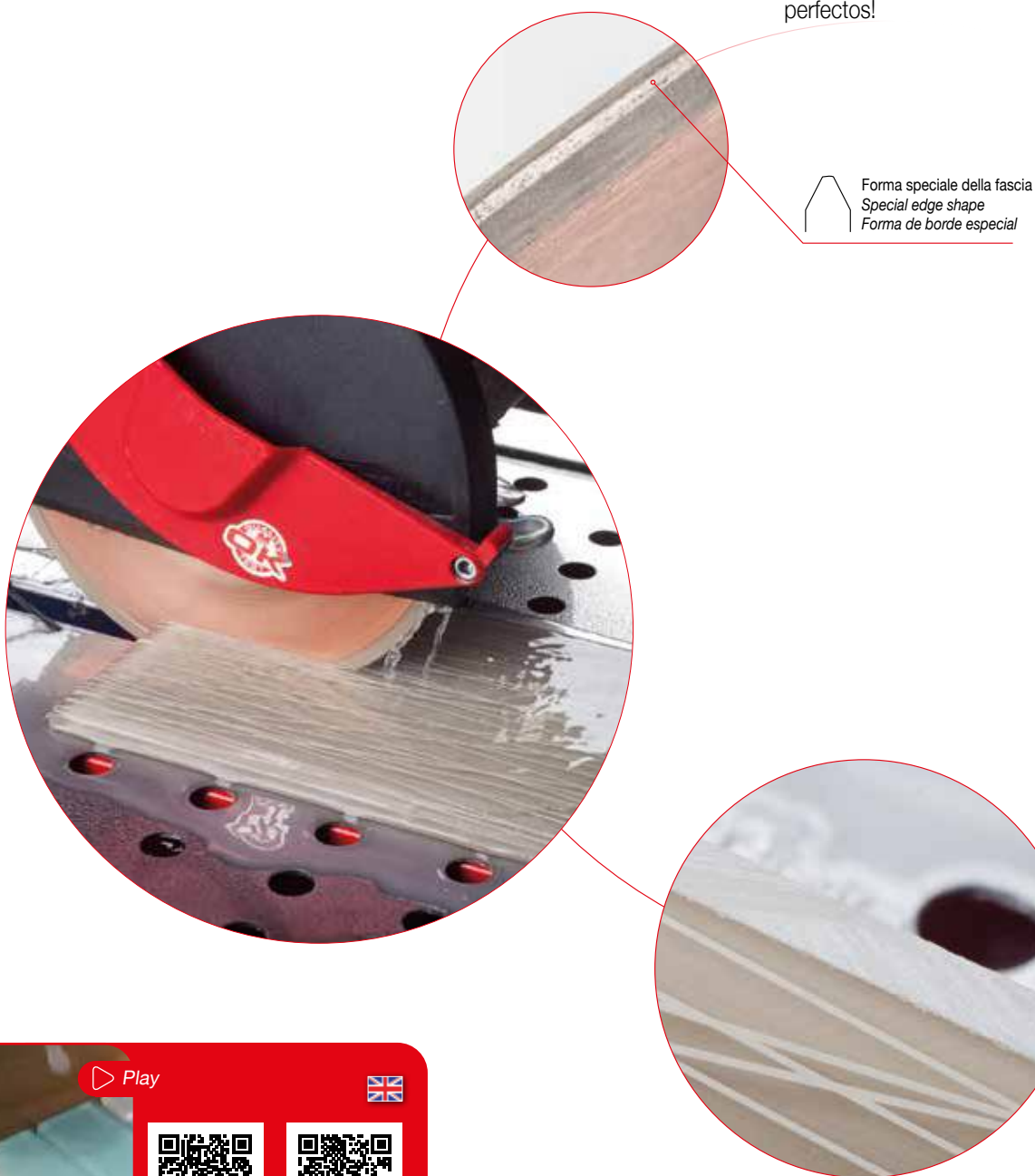

CERMONT - CONTINUOUS RIM

Piastrelle in vetro
Glass tiles
Baldosas de vidrio



SILVER LINE
"TOP"

Velocità - Speed - Velocidad	Durata - Life - Duración	Finitura - Finishing - Acabado
☆☆☆☆	☆☆☆☆	☆☆☆☆

Art.					EURO
	mm	inch	mm*	mm	
CPV100	100	4	22,2	1,4	142,00
CPV180	180	7	30/25,4	1,6	234,00
CPV200	200	8	30/25,4	1,6	245,00
CPV250	250	10	30/25,4	1,9	304,00
CPV300	300	12	30/25,4	2,1	322,00

* 5/8 inch: Riduzione a richiesta • Reduction on request • Reducción a pedido



Massima finitura, velocità ridotta, non forzare
Clean cut, low speed, don't force while cutting
Corte limpio a baja velocidad, no fuerce mientras corta

IT	GB	ES	
Piastrelle in vetro	Glass tiles	Baldosas de vidrio	☆☆☆☆
Mosaico vetroso	Glass mosaic	Mosaico de vidrio	☆☆☆☆
Mosaico in pietra naturale	Natural stone mosaic	Mosaico en piedra natural	☆☆☆☆☆

CERMONT - CONTINUOUS RIM

Ceramica/Gres porcellanato/Marmo/Granito
 Ceramic/Porcelain stoneware/Marble/Granite
 Cerámica/Gres porcelánico/Mármol/Granito



RED LINE
 "PROFESSIONAL"

10mm



Velocità - Speed - Velocidad	Durata - Life - Duración	Finitura - Finishing - Acabado
★★★★☆	★★★☆☆	★★★★☆

Art.					EURO
	mm	inch	mm	mm	
CPH180	180	7	25,4/22,2	1,6	73,00
CPH200	200	8	30/25,4	1,6	86,00
CPH230	230	9	30/25,4	1,6	98,00
CPH250	250	10	30/25,4	1,65	131,00
CPH300	300	12	30/25,4	2,0	160,00
CPH350	350	14	30/25,4	2,2	207,00

IT	GB	ES	
Gres porcellanato, klinker	Porcelain stoneware, klinker	Gres porcelánico, klinker	★★★★☆
Piastrelle in monocottura, cotto	Single-fired ceramic tiles, terracotta	Baldosas de cerámica, terracota	★★★★☆
Piastrelle in granito e pietra naturale	Granite tiles and natural stone	Baldosas de granito y piedras naturales	★★★☆☆
Piastrelle in marmo	Marble tiles	Baldosas de mármol	★★★★☆
Piastrelle in bicottura	Double fired glazed tiles	Baldosas de doble cocción	★★★☆☆

Massima velocità
 Max speed
 Máxima velocidad

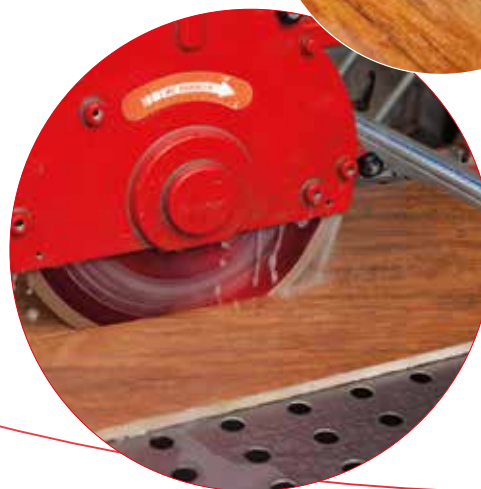

CERMONT - CONTINUOUS RIM

Gres Porcellanato/Ceramica delicata/Vetro/Marmo/Granito
 Porcelain stoneware/Soft ceramic/Glass/Marble/Granite
 Gres porcelánico/Cerámica esmaltada y delicada/Vidrio/
 Mármol/Granito



Velocità - Speed - Velocidad	Durata - Life - Duración	Finitura - Finishing - Acabado
★★★★	★★★☆☆	★★★★★



Massima finitura, velocità ridotta, non forzare
 Clean cut, low speed, don't force while cutting
 Corte limpio a baja velocidad, no fuerce mientras corta

Art.	Ø		Ø		EURO
	mm	inch	mm	mm	
CPF180	180	7	25,4/22,2	2,0	89,00
CPF200	200	8	30/25,4	2,0	101,00
CPF230	230	9	30/25,4	2,0	123,00
CPF250	250	10	30/25,4	2,0	147,00
CPF300	300	12	30/25,4	2,2	171,00
CPF350	350	14	30/25,4	2,2	226,00

IT	GB	ES	
Piastrelle in vetro	Glass tiles	Baldosas de vidrio	★★★★★
Gres porcellanato	Porcelain stoneware	Gres porcelánico	★★★★★
Piastrelle in monocottura e bicottura	Single-fired and double fired glazed tiles	Baldosas de cerámica y de doble cocción	★★★★★
Piastrelle in marmo	Marble tiles	Baldosas de mármol	★★★★☆
Piastrelle in granito e pietre naturali	Granite tiles and natural stone	Baldosas de granito y piedras naturales	★★★☆☆

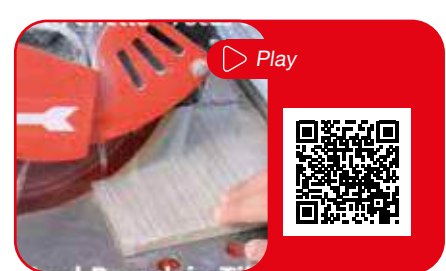

TURMONT - TURBO

Edilizia
Building industry
Construcción



BLU LINE
"UNIVERSAL"

Velocità - Speed - Velocidad	Durata - Life - Duración	Finitura - Finishing - Acabado
★★★★☆	★★★★☆	★★★★☆

Art.	Ø		Ø		EURO
	mm	inch	mm*	mm	
TEH115	115	4,5	22,2	2,2	35,00
TEH125	125	5	22,2	2,2	44,00
TEH230P	230	9	22,2	2,4	78,00

* 5/8 inch: Riduzione a richiesta • Reduction on request • Reducción a pedido

IT	GB	ES	
Tegole, laterizio, mattoni, calcestruzzo	Roof tiles, brick, concrete	Tejas, ladrillos, hormigón	★★★★☆
Autobloccanti, arenaria, poroton®	Self-locking bricks, sandstone, poroton®	Autobloqueantes, arenisca, poroton®	★★★★☆
Calcestruzzo leggermente armato, calcestruzzo abrasivo.	Lightly reinforced concrete, abrasive concrete.	Hormigón ligeramente armado, hormigón abrasivo.	★★★★☆
Granito, pietra, porfido	Granite, stone, porphyry	Granito, piedra, pórfido	★★★★☆
Marmo, ceramica, gres porcellanato.	Marble, ceramic, porcelain stoneware.	Mármol, cerámica, gres porcelánico.	★★★☆☆

TURMONT - TURBO PRO

Calcestruzzo/Granito/Gres porcellanato spessorato
Concrete/Granite/Porcelain stoneware high thickness
Hormigón/Granito/Gres porcelánico de gran espesor



RED LINE
"PROFESSIONAL"



Speciale per gres porcellanato alto spessore
Special for porcelain stoneware high thickness
Especial para gres porcelánico de alto espesor.

Velocità - Speed - Velocidad	Durata - Life - Duración	Finitura - Finishing - Acabado
★★★★☆	★★★★☆	★★★★☆

Art.	Ø		Ø		EURO
	mm	inch	mm*	mm	
TBH115 *	115	4,5	22,2	2,4	48,00
TBH125 *	125	5	22,2	2,4	53,00
TBH150	150	6	30/22,2	2,4	68,00
TBH180	180	7	22,2	2,4	74,00
TBH200	200	8	30/25,4	2,4	79,00
TBH230P	230	9	22,2	2,4	96,00
TBH250	250	10	30/25,4	2,8	129,00
TBH300	300	12	30/25,4	2,8	188,00
TBH350	350	14	30/25,4	3,3	258,00

IT	GB	ES	
Tegole, laterizio, mattoni, calcestruzzo	Roof tiles, brick, concrete	Tejas, ladrillos, hormigón	★★★★☆
Granito, pietra, porfido, refrattario	Granite, stone, porphyry, refractory	Granito, piedra, pórfido, refrattario	★★★★☆
Calcestruzzo leggermente armato, calcestruzzo abrasivo.	Lightly reinforced concrete, abrasive concrete.	Hormigón ligeramente armado, hormigón abrasivo.	★★★★☆
Autobloccanti, arenaria, poroton®	Self-locking bricks, sandstone, poroton®	Autobloqueantes, arenisca, poroton®	★★★★☆
Marmo, ceramica, gres porcellanato.	Marble, ceramic, porcelain stoneware.	Mármol, cerámica, gres porcelánico.	★★★☆☆

* 5/8 inch: Riduzione a richiesta • Reduction on request • Reducción a pedido

* XLOCK : A richiesta • On request • A pedido

LASERMONT - LASER

Edilizia
Building industry
Construcción



Velocità - Speed - Velocidad	Durata - Life - Duración	Finitura - Finishing - Acabado
★★★★☆	★★★★☆	★★★★☆

Art.	Ø		Ø		EURO
	mm	inch	mm*	mm	
LEH115	115	4,5	22,2	2,2	34,00
LEH125	125	5	22,2	2,2	43,00
LEH230P	230	9	22,2	2,4	76,00
LEH30018	300	12	30/25,4	2,8	139,00
LEH35021	350	14	30/25,4	3,2	172,00
LEH40024	400	16	30/25,4	3,4	200,00
LEH45026	450	18	30/25,4	3,6	229,00
LEH50029	500	20	30/25,4	3,6	285,00
LEH55032	550	22	30/25,4	4,0	310,00
LEH60035	600	24	60/50/25,4	4,0	381,00
LEH65037	650	26	60/50/25,4	4,0	431,00
LEH72040	720	29	60/50/25,4	4,0	601,00
LEH75042	750	30	60/50/25,4	4,0	618,00

* 5/8 inch: Riduzione a richiesta • Reduction on request • Reducción a pedido

LASERMONT - LASER PRO

Calcestruzzo/Granito/Porfido/Pietre dure
Concrete/Granite/Porphyry/Hard stone
Hormigón/Granito/Pórfido/Piedras duras



Velocità - Speed - Velocidad	Durata - Life - Duración	Finitura - Finishing - Acabado
★★★★★	★★★★★	★★★★☆

Art.	Ø		Ø		EURO
	mm	inch	mm*	mm	
LBH115	115	4,5	22,2	2,0	61,00
LBH125	125	5	22,2	2,2	69,00
LBH150 *	150	6	22,2	2,4	85,00
LBH160 *	160	6-5/16	22,2	2,4	102,00
LBH180 *	180	7	22,2	2,4	97,00
LBH190	190	7,5	22,2	2,4	118,00
LBH200	200	8	30/25,4	2,4	101,00
LBH230P	230	9	22,2	2,4	113,00
LBH250	250	10	30/25,4	2,4	130,00
LBH30021	300	12	30/25,4	2,8	166,00
LBH35025	350	14	30/25,4	3,2	212,00
LBH40028	400	16	30/25,4	3,2	239,00
LBH45032	450	18	30/25,4	3,4	286,00

* 5/8 inch: A richiesta • Reduction on request • Reducción a pedido

* A richiesta • On request • A pedido

LASERMONT- LASER

NEW 2025

Calcestruzzo fortemente armato/Granito/Porfido/Pietre dure/Ferro
Reinforced concrete/Granite/Porphyry/Hard stone/Iron
Hormigón fuertemente armado/Granito/Pórfido/Piedras duras/Hierro



SILVER LINE
"TOP"

10mm



Velocità - Speed - Velocidad	Durata - Life - Duración	Finitura - Finishing - Acabado
★★★★★	★★★★★	★★★☆☆

Art.	Ø		Ø		EURO
	mm	inch	mm*	mm	
LIH230	230	9	22,2	2,4	159,00

* 5/8 inch: Riduzione a richiesta • Reduction on request • Reducción a pedido

IT	GB	ES	
Calcestruzzo armato, calcestruzzo compatto	Reinforced concrete, compact concrete	Hormigón armado, hormigón compacto	★★★★★
Calcestruzzo molto armato, ferro d'armatura	Much reinforced concrete, reinforcing iron	Hormigón fuertemente armado, hierro de refuerzo	★★★★★
Autobloccanti, arenaria, poroton®, refrattario	Self-locking bricks, sandstone, poroton®, refractory	Autobloqueantes, arenisca, poroton®, refractario	★★★★★
Granito, pietra, porfido	Granite, stone, porphyry	Granito, piedra, pórfido	★★★★★
Tegole, laterizio, mattoni	Roof tiles, brick	Tejas, ladrillos	★★★★☆

SECTORMONT - SEGMENTS

Refrattario/Materiali abrasivi/Granito/Porfido
Refractory/Abrasive materials/Granite/Porphyry
Material refractario/Materiales abrasivos/Granito/Pórfido



SILVER LINE
"TOP"

10mm



Velocità - Speed - Velocidad	Durata - Life - Duración	Finitura - Finishing - Acabado
★★★★☆	★★★★★	★★★★☆

Art.	Ø		Ø		EURO
	mm	inch	mm	mm	
SR30021	300	12	30/25,4	3,0	286,00
SR35025	350	14	30/25,4	3,2	305,00
SR40028	400	16	30/25,4	3,5	363,00
SR45032	450	18	30/25,4	4,0	390,00
SR50030	500	20	30/25,4	4,5	464,00
SR55032 *	550	22	30/25,4	5,0	514,00
SR60036	600	24	30/25,4	5,0	621,00
SR65038 *	650	26	30/25,4	5,0	708,00

* A richiesta • On request • A pedido

IT	GB	ES	
Tegole in cotto, laterizio, mattoni	Terracotta roof tiles, bricks	Tejas de terracota, ladrillos	★★★★★
Granito, pietra naturale	Granite, natural stone	Granito, piedra natural	★★★★★
Autobloccanti, arenaria, poroton®	Self-locking bricks, sandstone, poroton®	Autobloqueantes, arenisca, poroton®	★★★★★
Tegole in cemento, mattoni abrasivi	Concrete roof tiles, abrasive bricks	Tejas de hormigón, ladrillos abrasivos.	★★★★☆
Refrattario	Refractory	Refractario	★★★★☆

DRAGSTER - MONDRILLO

Gres/Marmo/Granito/Calcestruzzo/Ghisa/Metallo/Fibra di vetro/Plastica
 Gres/Marble/Granite/Concrete/Cast iron/Metal plate/Fiberglass/Plastic
 Gres/Mármol/Granito/Hormigón/Hierro fundido/Metal/Fibra de vidrio/
 Plástico



SILVER LINE
"TOP"



Multipurpose

Velocità - Speed - Velocidad	Durata - Life - Duración	Finitura - Finishing - Acabado
★★★★★	★★★☆☆	★★★★★

Art.	Ø		Ø		EURO
	mm	inch	mm*		
SSD115	115	4,5	22,2		45,00
SSD125	125	5	22,2		49,00
SSD230	230	9	22,2		94,00
SSD300	300	12	30/25,4		175,00
SSD350	350	14	30/25,4		205,00

* 5/8 inch: Riduzione a richiesta • Reduction on request • Reducción a pedido



IT	GB	ES	
Granito, marmo, pietra naturale	Granite, marble, natural stone	Granito, mármol, piedra natural	★★★★★
Calcestruzzo, materiali edili.	Concrete, building materials	Hormigón, materiales de construcción	★★★★★
Barre in acciaio, tubi in ghisa.	Steel bars, cast iron pipes	Barras de acero, tubos de hierro fundido	★★★☆☆
Plastica, PVC, vetroresina, legno.	Plastic, PVC, fiberglass, wood	Plástico, PVC, fibra de vidrio, madera	★★★☆☆
Gres porcellanato, ceramica.	Porcelain stoneware, ceramic	Gres porcelánico, cerámica	★★★☆☆

ELECTROPLATED

Marmo/Fibre di vetro/Vetroresina
 Marble/Fiberglass
 Mármol/Fibras de vidrio



SILVER LINE
"TOP"



Velocità - Speed - Velocidad	Durata - Life - Duración	Finitura - Finishing - Acabado
★★★★★	★★★☆☆	★★★★★

Art.	Ø		Ø		EURO
	mm	inch	mm*		
ED115	115	4,5	22,2		56,00
ED125	125	5	22,2		60,00
ED180	180	7	22,2		90,00
ED200	200	8	22,2		95,00
ED230P	230	9	22,2		129,00
ED250	250	10	30/25,4		168,00
ED300	300	12	30/25,4		182,00
ED350	350	14	30/25,4		216,00

* 5/8 inch: Riduzione a richiesta • Reduction on request • Reducción a pedido

Marmo bianco e colorato.	White and colored marble	Mármol blanco y de color	★★★★★
Vetroresina, fibre di vetro.	Fiberglass	Fibra de vidrio	★★★☆☆
Plastica, PVC.	Plastic, PVC	Plástico, PVC	★★★☆☆

CERMONT - CONTINUOUS RIM

Gres porcellanato/Ceramica
Porcelain stoneware/Ceramic
Gres porcelánico/Cerámica



GREEN LINE
"BASIC"

Velocità - Speed - Velocidad	Durata - Life - Duración	Finitura - Finishing - Acabado
★★★★☆	★★★☆☆	★★★★☆

Art.	Ø		mm*		EURO
	mm	inch	mm*	mm	
CZ100	100	4	22,2/15,8	1,4	22,00
CZ115	115	4,5	22,2	1,4	24,00
CZ125	125	5	22,2	1,4	26,00
CZ180	180	7	22,2	1,6	48,00

* 5/8 inch: Riduzione a richiesta • Reduction on request • Reducción a pedido

TURMONT - CONTINUOUS RIM

Ceramica/Gres porcellanato
Ceramic/Porcelain stoneware
Cerámica/Gres porcelánico



GREEN LINE
"BASIC"

Velocità - Speed - Velocidad	Durata - Life - Duración	Finitura - Finishing - Acabado
★★★★☆	★★★☆☆	★★★★☆

Art.	Ø		mm*		EURO
	mm	inch	mm*	mm	
TCS100E	100	4	22,2/15,8	1,4	26,00
TCS115E	115	4,5	22,2	1,4	27,00
TCS125E	125	5	22,2	1,4	28,00

* 5/8 inch: Riduzione a richiesta • Reduction on request • Reducción a pedido

TURMONT - TURBO

Edilizia
Building industry
Construcción



GREEN LINE
"BASIC"

Velocità - Speed - Velocidad	Durata - Life - Duración	Finitura - Finishing - Acabado
★★★★☆	★★★☆☆	★★★★☆

Art.	Ø		mm*		EURO
	mm	inch	mm*	mm	
TZ115	115	4,5	22,2	2,0	25,00
TZ230P	230	9	22,2	2,6	52,00

* 5/8 inch: Riduzione a richiesta • Reduction on request • Reducción a pedido

Foratura
Drilling
Perforación



KILLER GRES - SINTERED DRY DRILLING

Gres porcellanato/Ceramica/Monocottura/Granito
 Porcelain stoneware/Hard ceramic/Granite/Marble
 Gres porcelánico/Cerámica dura/Granito/Mármol

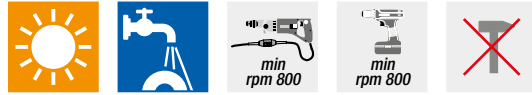

Velocità - Speed - Velocidad	Durata - Life - Duración	Finitura - Finishing - Acabado
★★★★☆	★★★★★	★★★★☆



Lunga durata
 Long Life
 Larga duración

Art.	Ø		max mm		EURO
	mm	inch			
FTJ05	5	3/16	10	30	45,00
FTJ06	6	1/4	10	30	49,00
FTJ08	8	5/16	10	30	50,00
FTJ10	10	3/8	10	30	54,00
FTJ12	12	1/2	10	30	70,00
FTJVA-N	Box + FTJ 05/06/08/10/12				244,00



6mm

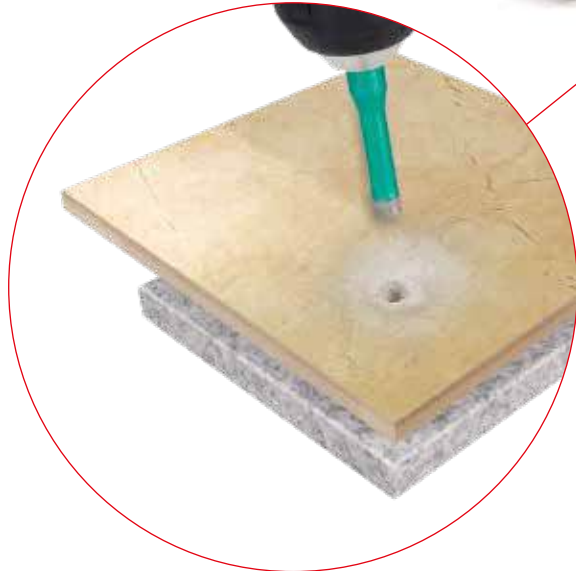

IT	GB	ES	
Gres porcellanato	Porcelain stoneware	Gres porcelánico	★★★★★
Piastrelle di monocottura, granito	Single-fired tiles, granite	Baldosas de cerámica, granito	★★★★★
Granito, pietre naturali	Granite, natural stones	Granito, piedras naturales	★★★★☆
Piastrelle di bicottura e vetrose	Double fired glazed tiles	Baldosas de doble cocción y vítreas	★★★★☆
Marmo e piastrelle in marmo	Marble and marble tiles	Mármol y baldosas de mármol	★★★☆☆



Art. FTJVA-N



pg. 94 → Liquido refrigerante
 → Cooling fluid
 → Líquido refrigerante

MONDRILLO - DRY DRILLING

Gres porcellanato/Ceramica/Monocottura/Granito/Marmo/Vetro
 Porcelain stoneware/Ceramic/Single fired tile/Granite/Marble/Glass
 Gres porcelánico/Cerámica/Granito/Mármol/Vidrio

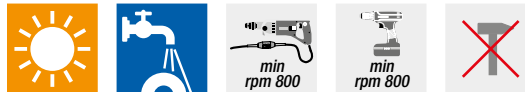

Velocità - Speed - Velocidad	Durata - Life - Duración	Finitura - Finishing - Acabado
★★★★	★★☆☆	★★★★



4th generation gold diamond technology

+ Velocità + Durata
 + Speed + Life
 + Velocidad + Vida

Gold spiral - new technology



Art.					EURO
	mm	inch	mm	max mm	
FAJ04	4	5/32	10	40	28,00
FAJ05	5	3/16	10	40	28,00
FAJ06	6	1/4	10	40	28,00
FAJ08	8	5/16	10	40	29,00
FAJ10	10	3/8	10	40	29,00
FAJ12	12	1/2	10	40	32,00
FAJVA-N	Box + FAJ 05/06/08/10/12				135,00
FAJ6VA	Box + 5 art.FAJ06				128,00
FAJ8VA	Box + 5 art.FAJ08				135,00

IT	GB	ES	
Gres porcellanato	Porcelain stoneware	Gres porcelánico	★★★★★
Piastrelle in monocottura, granito	Single-fired tiles, granite	Baldosas de cerámica, granito	★★★★★
Marmo e piastrelle in marmo	Marble and marble tiles	Mármol y baldosas de mármol	★★★★★
Piastrelle in bicottura e vetrose, vetro	Double fired glazed tiles, glass	Baldosas de doble cocción y vítreas, vidrio	★★★★☆
Piastrelle in granito e pietre naturali	Granite and natural stone tiles	Baldosas de granito y piedras naturales	★★★★☆



Art. FAJVA-N



pg. 107 → Espositore
 Display
 Expositor

pg. 94 → Liquido refrigerante
 Cooling fluid
 Líquido refrigerante



MONDRILLO - DRY DRILLING

NEW

Piastrelle in ceramica e pietra naturale
 Ceramic tiles and natural stone
 Baldosas de cerámica y piedra natural



Velocità - Speed - Velocidad	Durata - Life - Duración	Finitura - Finishing - Acabado
★★★★	★★☆☆	★★★★☆



12mm



Art.	Ø		M14 *	max mm	EURO
	mm	inch			
FSBH 06	6	1/4	M14 *	35	33,00
FSBH 08	8	5/16	M14 *	35	34,00
FSBH 10	10	3/8	M14 *	35	35,00
FSBH 12	12	1/2	M14 *	35	36,00
FSBH 14	14	9/16	M14 *	35	37,00
FSBH 16	16	5/8	M14 *	35	39,00
FSBH 18	18	11/16	M14 *	35	41,00
FSBH 20	20	3/4	M14 *	35	42,00
FSBH 25	25	1	M14 *	35	43,00
FSBH 27	27	1-1/16	M14 *	35	45,00
FSBH 30	30	1-3/16	M14 *	35	49,00
FSBH 35	35	1-3/8	M14 *	35	56,00
FSBH 40	40	1-1/2	M14 *	35	61,00
FSBH 45	45	1-3/4	M14 *	35	68,00
FSBH 50	50	2	M14 *	35	75,00
FSBH 55	55	2-3/16	M14 *	35	80,00
FSBH 60	60	2-3/8	M14 *	35	88,00
FSBH 65	65	2-1/2	M14 *	35	95,00
FSBH 68	68	2-11/16	M14 *	35	98,00
FSBH 70	70	2-3/4	M14 *	35	101,00
FSBH 75	75	3	M14 *	35	108,00
FSBH 90	90	3-9/16	M14 *	35	130,00
FSBH100	100	4	M14 *	35	150,00
FSBH120	120	4-3/4	M14 *	35	180,00
FSBHKIT-IT	Box + FSB08 + FSB20 + FSB27 + FSB35 + FSB50				198,00

* 5/8 inch: Riduzione a richiesta • Reduction on request • Reducción a pedido



Art. FSBHKIT-IT

IT	GB	ES	
Gres porcellanato	Porcelain stoneware	Gres porcelánico	★★★★★
Piastrelle in granito e pietre naturali	Granite and natural stone tiles	Baldosas de granito y piedras naturales	★★★★★
Piastrelle in monocottura, granito	Single-fired tiles, granite	Baldosas de cerámica, granito	★★★★★
Marmo e piastrelle in marmo	Marble and marble tiles	Mármol y baldosas de mármol	★★★★★
Piastrelle in bicottura e vetrose	Double fired glazed tiles	Baldosas de doble cocción	★★★★☆



pg. 94
 → Liquido refrigerante
 → Cooling fluid
 → Liquido refrigerante



MONDRILLO TITANIUM GOLD - DRY DRILLING



Gres Porcellanato/Ceramica dura/Granito/Marmo
 Porcelain stoneware/Hard ceramic/Granite/Marble
 Gres porcelánico/Cerámica dura/Granito/Mármol



Velocità - Speed - Velocidad	Durata - Life - Duración	Finitura - Finishing - Acabado
★★★★★	★★★★☆	★★★★☆



Art.	Ø		M14 *	max mm	EURO
	mm	inch			
FS-TI 6	6	1/4	M14 *	35	49,00
FS-TI 8	8	5/16	M14 *	35	52,00
FS-TI 10	10	3/8	M14 *	35	58,00
FS-TI 12	12	1/2	M14 *	35	59,00
FS-TI 14	14	9/16	M14 *	35	62,00
FS-TI 16	16	5/8	M14 *	35	65,00
FS-TI 18	18	11/16	M14 *	35	66,00
FS-TI 20	20	3/4	M14 *	35	69,00
FS-TI 25	25	1	M14 *	35	79,00
FS-TI 27	27	1-1/16	M14 *	35	88,00
FS-TI 30	30	1-3/16	M14 *	35	94,00
FS-TI 35	35	1-3/8	M14 *	35	99,00
FS-TI 40	40	1-1/2	M14 *	35	115,00
FS-TI 45	45	1-3/4	M14 *	35	123,00
FS-TI 50	50	2	M14 *	35	128,00
FS-TI 55	55	2-3/16	M14 *	35	146,00
FS-TI 60	60	2-3/8	M14 *	35	162,00
FS-TI 65	65	2-1/2	M14 *	35	166,00
FS-TI 68	68	2-11/16	M14 *	35	172,00
FS-TI 70	70	2-3/4	M14 *	35	174,00
FS-TI 75	75	3	M14 *	35	182,00
FS-TI100	100	4	M14 *	35	294,00
FS-TI120	120	4-3/4	M14 *	35	353,00
FS-TI_KIT-IT	Box + FS-TI8 + FS-TI20 + FS-TI27 + FS-TI35 + FS-TI50			358,00	

* 5/8 inch: Riduzione a richiesta • Reduction on request • Reducción a pedido



Art. FS-TI_KIT-IT

Art. AUFS
 EURO 19,00



Raccordo per trapano - M14
 Adapter for drill - M14
 Racor para taladro - M14

IT	GB	ES	
Gres porcellanato	Porcelain stoneware	Gres porcelánico	★★★★★
Piastrelle in granito e pietre naturali	Granite and natural stone tiles	Baldosas de granito y piedras naturales	★★★★★
Piastrelle in monocottura, granito	Single-fired tiles, granite	Baldosas de cerámica, granito	★★★★★
Marmo e piastrelle in marmo	Marble and marble tiles	Mármol y baldosas de mármol	★★★★★
Piastrelle in bicottura e vetrose	Double fired glazed tiles	Baldosas de doble cocción y vítreas	★★★★☆



pg. 94 → Liquido refrigerante
 → Cooling fluid
 Líquido refrigerante

KILLER GRES - SINTERED DRY DRILLING

Gres porcellanato/Ceramica dura/Granito
 Porcelain stoneware/Hard ceramic/Granite
 Gres porcelánico/Cerámica dura/Granito



Velocità - Speed - Velocidad	Durata - Life - Duración	Finitura - Finishing - Acabado
★★★★☆	★★★★★	★★★★☆

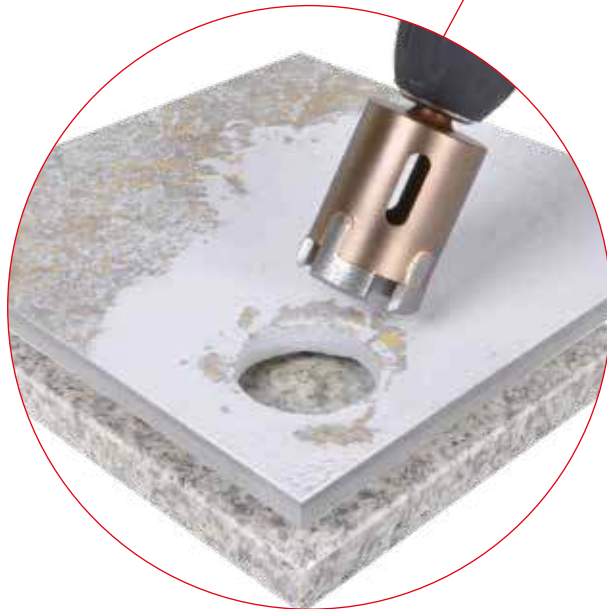

Art.	Ø		max mm		EURO
	mm	inch	mm	max mm	
FT 6	6	1/4	10	45	84,00
FT 8	8	5/16	10	45	88,00
FT 10	10	3/8	10	45	90,00
FT 15	15	5/8	10	45	110,00
FT 20	20	3/4	10	45	114,00
FT 27	27	1-1/16	10	45	144,00
FT 35	35	1-3/8	10	45	158,00
FT 40	40	1-1/2	10	45	165,00
FT 50	50	2	10	45	189,00
FT 60	60	2-3/8	10	45	223,00
FT 65	65	2-1/2	10	45	232,00
FT 75	75	3	10	45	252,00
FT100	100	4	10	45	342,00
FT120	120	4-3/4	10	45	414,00

IT	GB	ES	
Gres porcellanato	Porcelain stoneware	Gres porcelánico	★★★★★
Piastrelle in granito e pietre naturali	Granite and natural stone tiles	Baldosas de granito y piedras naturales	★★★★★
Piastrelle in monocottura, granito	Single-fired tiles, granite	Baldosas de cerámica, granito	★★★★☆
Marmo e piastrelle in marmo	Marble and marble tiles	Mármol y baldosas de mármol	★★★☆☆



pg. 94 → Liquido refrigerante
 → Cooling fluid
 Líquido refrigerante

KILLER GRES - SINTERED DRY DRILLING

Gres porcellanato alto spessore/Ceramica dura/Granito
 Porcelain stoneware high thickness/Hard ceramic/Granite
 Gres porcelánico de gran espesor/Cerámica dura/Granito



Velocità - Speed - Velocidad	Durata - Life - Duración	Finitura - Finishing - Acabado
★★★★	★★★★	★★★★☆



Speciale per gres porcellanato alto spessore
 Special for porcelain stoneware high thickness
 Especial para gres porcelánico de alto espesor.

8mm



Art.	Ø		mm	max mm	MAX rpm	EURO
	mm	inch				
FT-S 6	6	1/4	M14	40	6.000	98,00
FT-S 8	8	5/16	M14	40	6.000	100,00
FT-S10	10	3/8	M14*	40	6.000	101,00
FT-S12	12	1/2	M14*	40	6.000	110,00
FT-S15	15	5/8	M14*	50	12.000	122,00
FT-S20	20	3/4	M14*	50	12.000	138,00
FT-S25	25	1	M14*	50	12.000	160,00
FT-S27	27	1-1/16	M14*	50	12.000	164,00
FT-S30	30	1-3/16	M14*	50	12.000	167,00
FT-S35	35	1-3/8	M14*	50	12.000	171,00
FT-S40	40	1-1/2	M14*	50	12.000	184,00
FT-S43	43	1-11/16	M14*	50	12.000	196,00
FT-S50	50	2	M14*	50	12.000	212,00
FT-S55	55	2-3/16	M14*	50	12.000	225,00
FT-S60	60	2-3/8	M14*	50	12.000	234,00
FT-S65	65	2-1/2	M14*	50	12.000	243,00
FT-S70	70	2-3/4	M14*	50	12.000	258,00
FT-S100	100	4	M14*	50	4.000	370,00
FT-S120	120	4-3/4	M14*	50	4.000	454,00
FTSKIT-IT	Box + FT-S20 + FT-S35 + FT-S50					488,00

* 5/8 inch: Riduzione a richiesta • Reduction on request • Reducción a pedido

IT	GB	ES	
Gres porcellanato alto spessore	Porcelain stoneware high thickness	Gres porcelánico de alto espesor	★★★★★
Gres porcellanato	Porcelain stoneware	Gres porcelánico	★★★★★
Piastrelle in granito e pietre naturali	Granite and natural stone tiles	Baldosas de granito y piedras naturales	★★★★★
Piastrelle in monocottura	Single-fired tiles	Baldosas de cerámica	★★★★☆
Marmo e piastrelle in marmo	Marble and marble tiles	Mármol y baldosas de mármol	★★★☆☆



pg. 94 → Liquido refrigerante
 → Cooling fluid
 → Líquido refrigerante

pg. 107 → Espositore
 → Display
 → Expositor



MANGIATUTTO - SINTERED WET DRILLING

Gres porcellanato/Ceramica/Monocottura/Granito/Marmo
 Porcelain stoneware/Ceramic/Single fired tile/Granite/Marble
 Gres porcelánico/Cerámica/Monocuisson/Granito/Mármol



Velocità - Speed - Velocidad	Durata - Life - Duración	Finitura - Finishing - Acabado
★★★★☆	★★★★★	★★★★★

Art.	Ø		max mm		EURO
	mm	inch	mm	max mm	
MU 5	5	3/16	10	45	51,00
MU 6	6	1/4	10	45	53,00
MU 8	8	5/16	10	45	56,00
MU10	10	3/8	10	45	64,00
MU12	12	1/2	10	45	75,00
MU14	14	9/16	10	45	84,00

IT	GB	ES	
Piastrelle in monocottura, granito	Single-fired tiles, granite	Baldosas de cerámica, granito	★★★★★
Piastrelle in granito e pietre naturali	Granite and natural stone tiles	Baldosas de granito y piedras naturales	★★★★★
Piastrelle in bicottura e vetrose	Double fired glazed tiles	Baldosas de doble cocción y vítreas	★★★★★
Gres porcellanato	Porcelain stoneware	Gres porcelánico	★★★★★
Marmo e piastrelle in marmo	Marble and marble tiles	Mármol y baldosas de mármol	★★★★☆

SINTERIZED - WET DRILLING

Piastrelle in vetro/Ceramica delicata
 Glass tiles/Soft ceramic
 Baldosas de vidrio/Cerámicas delicadas

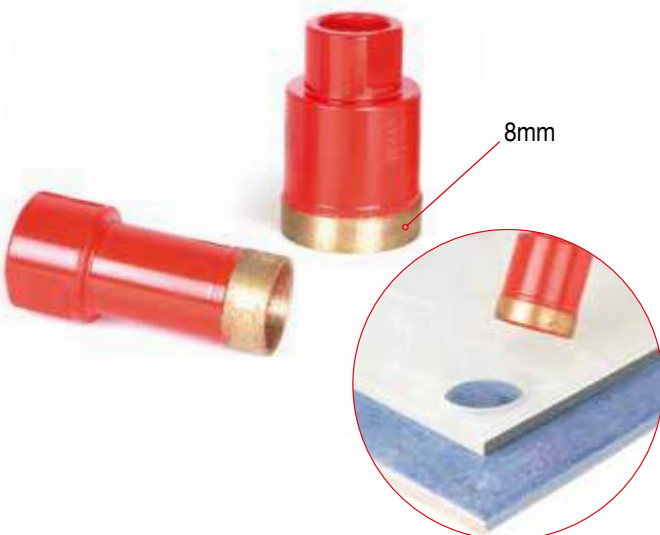

Velocità - Speed - Velocidad	Durata - Life - Duración	Finitura - Finishing - Acabado
★★★★☆	★★★★☆	★★★★★

Art.	Ø		max mm		EURO
	mm	inch	mm	max mm	
FAV20	20	3/4	M16	30	119,00
FAV28	28	1-1/16	M16	30	128,00
FAV35	35	1-3/8	M16	30	132,00
FAV51	51	2	M16	30	154,00
FAV65	65	2-1/2	M16	30	183,00

IT	GB	ES	
Piastrelle in vetro	Glass tiles	Baldosas de vidrio	★★★★★
Piastrelle in bicottura e vetrose	Double fired glazed tiles	Baldosas de doble cocción	★★★★★
Gres porcellanato	Porcelain stoneware	Gres porcelánico	★★★★☆
Marmo e piastrelle in marmo	Marble and marble tiles	Mármol y baldosas de mármol	★★★★☆



pg. 96 →

SINTERIZED - WET DRILLING

Gres porcellanato/Ceramica/Monocottura/Granito/Marmo
 Porcelain stoneware/Ceramic/Single fired tile/Granite/Marble
 Gres porcelánico/Cerámica/Monocuisson/Granito/Mármol



Velocità - Speed - Velocidad	Durata - Life - Duración	Finitura - Finishing - Acabado
★★★★☆	★★★★☆	★★★★☆



Art.	Ø		M16	max mm	EURO
	mm	inch			
FA 20	20	3/4	M16	45	85,00
FA 27	27	1-1/16	M16	45	86,00
FA 30	30	1-3/16	M16	45	88,00
FA 32	32	1-1/4	M16	45	89,00
FA 35	35	1-3/8	M16	45	90,00
FA 40	40	1-1/2	M16	45	94,00
FA 45	45	1-3/4	M16	45	96,00
FA 50	50	2	M16	45	102,00
FA 55	55	2-3/16	M16	45	113,00
FA 60	60	2-3/8	M16	45	124,00
FA 65	65	2-1/2	M16	45	126,00
FA 70	70	2-3/4	M16	45	135,00
FA 75	75	3	M16	45	141,00
FA100	100	4	M16	45	180,00
FA120	120	4-3/4	M16	45	222,00

VAF01	BOX + 88 + FA20 + FA27 + FA30 + FA35 + FA40+ FA45 + FA50 + FA65 + FA75 + FA100 + FA120	1.225,00
VAF01	BOX	68,00

IT	GB	ES	
Gres porcellanato	Porcelain stoneware	Gres porcelánico	★★★★☆
Piastrelle in monocottura, granito	Single-fired tiles, granite	Baldosas de cerámica, granito	★★★★☆
Marmo e piastrelle in marmo	Marble and marble tiles	Mármol y baldosas de mármol	★★★★☆
Piastrelle in bicottura e vetrose	Double fired glazed tiles	Baldosas de doble cocción	★★★★☆
Granito, pietre naturali	Granite, natural stone	Granito, piedras naturales	★★★★☆

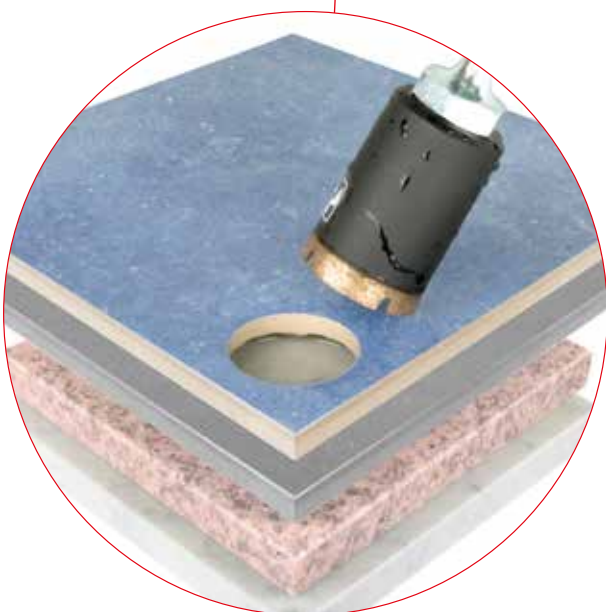

Art. AUFA
EURO 19,00



Art. 88
EURO 72,00



Art. VTKIT
EURO 53,00



pg. 96 →

MONDRILLO PERFORMER

Art. M-Performer

EURO 16,00

IT Fluido refrigerante per prestazioni ottimali delle punte diamantate.

GB Cooling fluid for optimal performance of diamond core bits.

ES Líquido refrigerante para el rendimiento óptimo de puntas de diamante.



STONE SUPERCUT

IT Ravvivatori per utensili diamantati

GB Grindstone for dressing diamond tools

ES Piedra de afilar para herramientas diamantadas



Art.

EURO

Art.		EURO
395-2U	Special Multipurpose (206 x 73 x 30 mm)	48,00
395BJ	Junior (80 x 50 x 20 mm)	17,00

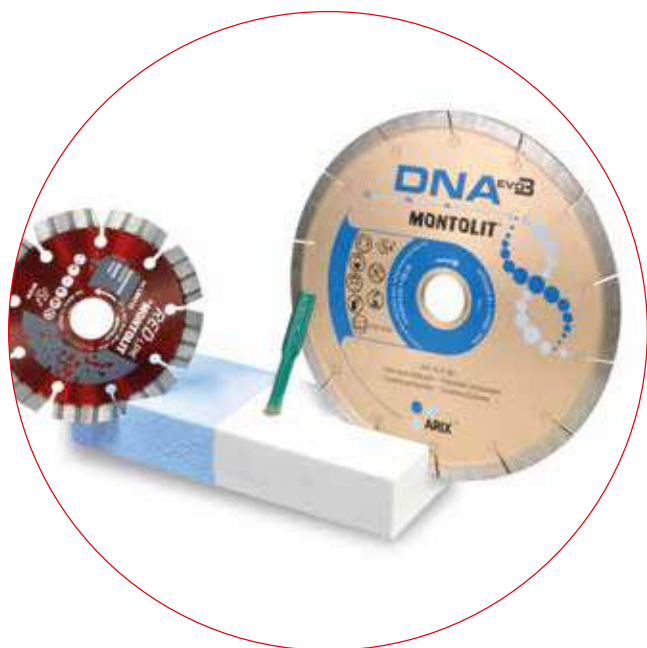

Art. 395BJ

Art. 395-2U

SAFE DIAMOND BOX

Art. SDB

EURO 56,00

- IT Custodia protettiva per utensili diamantati.
- GB Safe case for diamond tools.
- ES Caja para herramientas diamantadas.



JUNIOR SAFE DIAMOND BOX

NEW

Art. SDB JUNIOR

EURO 39,00

- IT Custodia protettiva per utensili diamantati.
- GB Safe case for diamond tools.
- ES Caja para herramientas diamantadas.



ACCESSORI PER LA FORATURA AD ACQUA

EQUIPMENT FOR WET DRILLING - EQUIPOS PARA LA PERFORACIÓN CON AGUA

Art. PS92 EURO 33,00	Raccordo portapunta per MU (x artt. 915/916/CVG12) <i>Drill-holder connector for MU (x artt. 915/916/CVG12)</i> <i>Eganche portapunta MU (x artt. 915/916/CVG12)</i>	
Art. AUFA EURO 19,00	Raccordo per trapano - M16 (x artt. FA/FAV) <i>Adapter for drill - M16 (x artt. FA/FAV)</i> <i>Adaptador para taladro - M16 (x artt. FA/FAV)</i>	
Art. 88 EURO 72,00	Mandrino a punta centrale retraente - M16 (x artt. FA/FAV) <i>Arbor with central retractable bit - M16 (x artt. FA/FAV)</i> <i>Mandril con punta central retráctil - M16 (x artt. FA/FAV)</i>	
Art. CVG12 EURO 160,00	Convogliatore d'acqua completo di tanica <i>Water feed complete with jerry</i> <i>Depósito de agua con bidón</i>	
Art. VTKIT EURO 53,00	Ventose per foratura con acqua (Ø 40mm + Ø 60mm) <i>Suction cups for water drilling (Ø 40mm + Ø 60mm)</i> <i>Ventosas para perforación con agua (Ø 40mm + Ø 60mm)</i>	
Art. 89 EURO 21,00	Riduzione M16 - G 1/2" <i>M16 - G 1/2" adapter</i> <i>Adaptador M16 - G 1/2"</i>	

GUIDA ALLA SCELTA DI FRESE E PUNTE DIAMANTATE

SELECTION GUIDE OF DIAMOND CORE-BITS • GUÍA PARA LA ELECCIÓN DE FRESAS Y PUNTAS DIAMANTADAS

	MOD.	UTILIZZO / USE / USAR
mm 4 5/32	FAJ	tasselli / wall plugs / tacos de pared
5 3/16	FAJ / FTJ / MU	tasselli / wall plugs / tacos de pared
6 1/4	FAJ / FS / FTJ / FT-S / MU	tasselli / wall plugs / tacos de pared
8 5/16	FAJ / FS / FTJ / FT-S / MU	tasselli / wall plugs / tacos de pared
10 3/8	FAJ / FS / FTJ / FT-S / FT / MU	tasselli / wall plugs / tacos de pared
12 1/2	FAJ / FS / FTJ / FT-S / MU	tasselli, fermaporta / wall plugs, door stopper / tacos de pared, tope de puerta
14 9/16	FS / MU	tasselli, fermaporta / wall plugs, door stopper / tacos de pared, tope de puerta
15 5/8	FT / FT-S	tubo 1/4", tasselli, fermaporta / 1/4" tube, wall plugs, door stopper / tubería 1/4, tacos de pared, tope de puerta
16 5/8	FS	incasso porte blindate / recess armored doors / puertas blindadas empotradas
18 11/16	FS	tubo 3/8" in rame per gas, acqua / 3/8" copper tube for gas, water / tubería de cobre de 3/8 para gas, agua
20 3/4	FA / FS / FT / FT-S / FAV	tubo 3/8" in rame per gas, acqua / 3/8" copper tube for gas, water / tubería de cobre de 3/8 para gas, agua
25 1	FS / FT-S	tubo 1/2" acqua, rubinetti, riscaldamento, civile / 1/2" tube fucets system, heating system / 1/2" tubería de agua, grifos, calefacción, civil
27 1-1/16	FA / FS / FT / FT-S / FAV	tubo 1/2" acqua, rubinetti, riscaldamento, civile / 1/2" tube fucets system, heating system / 1/2" tubería de agua, grifos, calefacción, civil
30 1-3/16	FA / FS / FT-S	tubo 3/4" acqua, rubinetti, riscaldamento, civile / 3/4" tube fucets system, heating system / 3/4" tubería de agua, grifos, calefacción, civil
32 1-1/4	FA	tubo 3/4" acqua, rubinetti, riscaldamento, civile / 3/4" tube fucets system, heating system / 3/4" tubería de agua, grifos, calefacción, civil
35 1-3/8	FA / FS / FT / FT-S	tubo 1" ferro o pvc per acqua, gas, industriale / 1" iron or pvc tube for water, gas, industrial use / tubería de hierro o pvc de 1" para agua, gas, industrial
40 1-1/2	FA / FS / FT / FT-S	tubo 1" ferro o pvc per acqua, gas, industriale / 1" iron or pvc tube for water, gas, industrial use / tubería de hierro o pvc de 1" para agua, gas, industrial
43 1-11/16	FT-S	tubo 1-1/4" scarico lavello, lavandino, lavastoviglie / 1-1/4" drainage system for bathroom, kitchen, sink / tubo de desagüe de 1-1/4" lavabo, fregadero, lavavajillas
45 1-3/4	FA / FS	tubo 1-1/4" scarico lavello, lavandino, lavastoviglie / 1-1/4" drainage system for bathroom, kitchen, sink / tubo de desagüe de 1-1/4" lavabo, fregadero, lavavajillas
50 2	FA / FS / FT / FT-S / FAV	tubo 1-1/4" scarico lavello, lavandino, lavastoviglie / 1-1/4" drainage system for bathroom, kitchen, sink / tubo de desagüe de 1-1/4" lavabo, fregadero, lavavajillas
55 2-3/16	FA / FS / FT-S	tubo 1-1/2" scarico lavatrice / 1-1/2" waste pipe for washing machine, drain system / tubo de desagüe de lavadora de 1-1/2"
60 2-3/8	FA / FS / FT / FT-S	tubo 1-1/2" scarico lavatrice / 1-1/2" waste pipe for washing machine, drain system / tubo de desagüe de lavadora de 1-1/2"
65 2-1/2	FA / FS / FT / FT-S / FAV	tubo 1-1/2" scarico lavatrice / 1-1/2" waste pipe for washing machine, drain system / tubo de desagüe de lavadora de 1-1/2"
68 2-11/16	FS	faretti ad incasso, tubo 2" / recessed spotlight, 2" tube / focos empotrables, tubo de 2"
70 2-3/4	FA / FS / FT-S	tubo 2" scarico lavatrici industriali, raccordi pvc, piscine / 2" waste pipe for washing machine, pvc connection pipe and swimmingpool / tubo de desagüe de 2" lavadoras industriales, conexiones de pvc, piscinas
75 3	FA / FS / FT	tubo 2" o 2-1/2" scarico lavatrici industriali, raccordi pvc, piscine / 2" o 2-1/2" waste pipe for washing machine, pvc connection pipe and swimmingpool / tubo de desagüe de 2" o 2-1/2" lavadoras industriales, conexiones de pvc, piscinas
100 4	FA / FS / FT / FT-S	tubo 3" scarico wc, presa aria cucina - caldaia / 3" flushing system pipe for wc, ventilation outlet for kitchen-boiler / 3" tubería de desagüe del wc, toma de ventilación de la cocina - calentador
120 4-3/4	FA / FS / FT / FT-S	presa aria cucina - caldaia / ventilation outlet for kitchen-boiler / toma de ventilación de la cocina - calentador

Lavorazioni speciali
Special works
Obras especiales

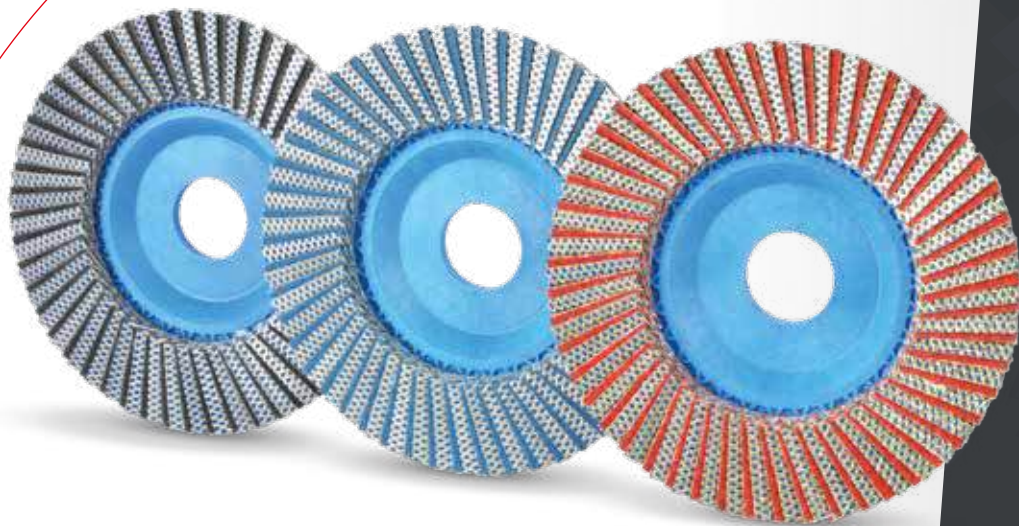

MONDRILLO

IT Fresa diamantata universale per allargare e sagomare i fori
 GB Universal diamond milling bit for enlarging and shaping holes
 ES Fresa diamantada universal para ensanchar, o dar forma a perforaciones



Art. FPU20



Art.	Ø		M14*	max mm	EURO
	mm	inch			
FPUS6	6	1/4	M14*	35	74,00
FPU20	20	3/4	M14*	50	108,00

* 5/8 inch: Riduzione a richiesta • Reduction on request • Reducción a pedido

Gres porcellanato/Ceramica/Granito/Marmo/Vetro
 Porcelain stoneware/Ceramic/Granite/Marble/Glass
 Gres porcelánico/Cerámica/Granito/Mármol/Vidrio



MONDRILLO

IT Frese coniche diamantate a profilo svasatore per la rifinitura dei fori
 GB Diamond countersink tool (dry or wet use) for finishing holes
 ES Fresas cónicas diamantadas con perfil de avellanador para el pulido de los orificios



Art. FPS75

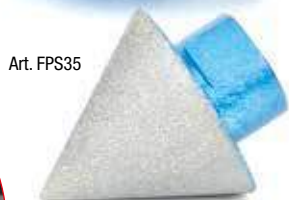

Art. FPS35



Art.	Ø		M14*	EURO
	mm	inch		
FPS35	5 ÷ 35	3/16 ÷ 1-3/8	M14*	125,00
FPS75	35 ÷ 75	1-3/8 ÷ 3	M14*	230,00

* 5/8 inch: Riduzione a richiesta • Reduction on request • Reducción a pedido

Gres porcellanato/Ceramica/Granito/Marmo/Vetro
 Porcelain stoneware/Ceramic/Granite/Marble/Glass
 Gres porcelánico/Cerámica/Granito/Mármol/Vidrio



MONDRILLO

- IT Mola diamantata per "piletta lavabo"
- GB Diamond grinding wheel for "sink drain"
- ES Muela de diamante para desagüe de lavabo

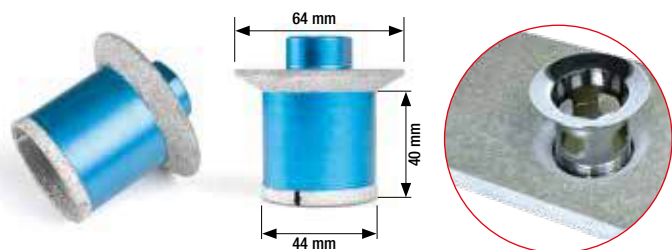

Art.		EURO
FP-PI	M14 *	208,00

* 5/8 inch: Riduzione a richiesta • Reduction on request • Reducción a pedido

Gres porcellanato/Granito/Marmo/Resine sintetiche
 Porcelain stoneware/Granite/Marble/Synthetic resins
 Gres porcelánico/Granito/Mármol/Resinas sintéticas

MONDRILLO - AFTERCUT

- IT Profilatore antirottura
- GB Edge cleaner
- ES Perfilador anti-rotura



Art.		EURO
AFTERCUT	M14 *	148,00

* 5/8 inch: Riduzione a richiesta • Reduction on request • Reducción a pedido

Gres porcellanato/Ceramica
 Porcelain stoneware/Ceramic
 Gres porcelánico/Cerámica



MONDRILLO

- IT Scontornatori diamantati
- GB Diamond bevel profiles
- ES Herramienta diamantada para perfiles

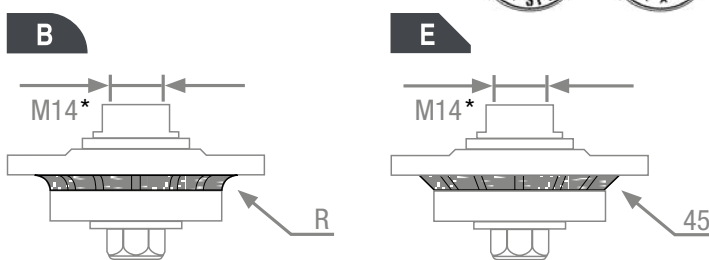

Gres porcellanato/Granito/Marmo
 Porcelain stoneware/Granite/Marble
 Gres porcelánico/Granito/Mármol

Art.	Tipo / type / tipo	EURO
B03	B = R 3mm	156,00
B05	B = R 5mm	164,00
B10	B = R 10mm	174,00
E03	E = 45° 3mm	156,00
E05	E = 45° 5mm	162,00
B03-D	B = R 3mm	77,00
B05-D	B = R 5mm	84,00
B10-D	B = R 10mm	96,00
E03-D	E = 45° 3mm	77,00
E05-D	E = 45° 5mm	84,00

* 5/8 inch: Riduzione a richiesta • Reduction on request • Reducción a pedido



MONDRILLO



IT Mola diamantata per profilo tipo "V"
 GB Diamond grinding wheel for "V" type profile
 ES Muela de diamante para perfil tipo "V"



V



Art.			EURO
FPV22	"V" Profile - R = 22mm	M14*	413,00

* 5/8 inch: Riduzione a richiesta • Reduction on request • Reducción a pedido

Gres porcellanato/Granito/Marmo
 Porcelain stoneware/Granite/Marble
 Gres porcelánico/Granito/Mármol



MONDRILLO

IT Mola diamantata per profilo antiscivolo
 GB Diamond grinding wheel for non slip profile
 ES Muela de diamante para perfil antideslizante



Art.			EURO
FP-AS	20+20mm (3/4 + 3/4")	M14*	356,00

* 5/8 inch: Riduzione a richiesta • Reduction on request • Reducción a pedido

Gres porcellanato/Granito/Marmo
 Porcelain stoneware/Granite/Marble
 Gres porcelánico/Granito/Mármol



MONDRILLO

IT Mola diamantata per "gocciolatoio"
 GB Diamond grinding wheel for "drip"
 ES Muela de diamante para "goteo"



Art.			EURO
FP-GO		M14*	186,00

* 5/8 inch: Riduzione a richiesta • Reduction on request • Reducción a pedido

Gres porcellanato/Granito/Marmo
 Porcelain stoneware/Granite/Marble
 Gres porcelánico/Granito/Mármol

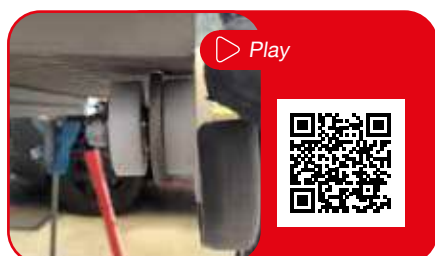

PADS

IT Platorelli diamantati resinoidi con attacco velcro™ per la levigatura e lucidatura. Gres porcellanato/Granito/Marmo/Vetro.

GB Diamond resin polishing pads with Velcro coupling for grinding and polishing - Porcelain stoneware/Granite/Marble/Glass.

ES Almohadillas de pulido de resina de diamante - con unión Velcro™ - para el esmerilado y pulido - Gres porcelánico/Granito/Mármol/Vidro



Art.

EURO

Art.		EURO
PDR	M14*	46,00
PDR 0	Step "0"	48,00
PDR 1	Step "1"	40,00
PDR 2	Step "2"	40,00
PDR 3	Step "3"	40,00
PDRKIT	Step "1 + 2 + 3"	112,00

* 5/8 inch: Riduzione a richiesta • Reduction on request • Reducción a pedido

Art. PDRKIT



Art. PDR



Art. PDR0

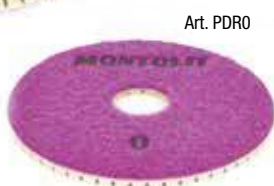

MASTERTECH

IT Tamponi diamantati per sgrossare e rifinire

GB Diamond hand pads for smoothing the edges

ES Almohadillas de diamante para el pulido y acabado



Art.

EURO

Art.		EURO
DT262	Blister: 1 art. DT060 + 1 art. DT200	60,00
DT606	Box: 6 artt. DT060 - Medium	200,00
DT620	Box: 6 artt. DT200 - Fine	140,00



Art. DT200 - Fine

Monocottura/Bicottura/Marmo/Vetro
Ceramic/Double fired tile/Marble/Glass
Monococción/Doble cocción/Mármol/Vidro



Art. DT060 - Medium

Gres porcellanato/Klinker/Granito
Porcelain stoneware/Klinker/Granit
Gres porcelánico/Klinker/Granito

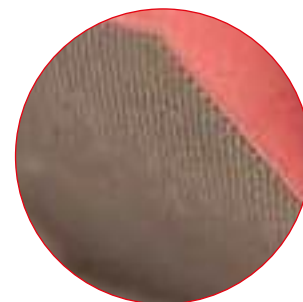
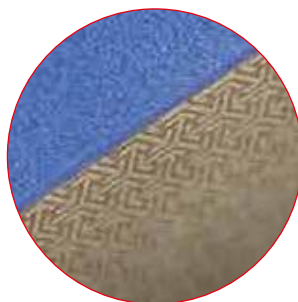

Art.

Grana / Grain / Grano

Color

EURO

Art.	Grana / Grain / Grano	Color	EURO
DF60	60		44,00
DF120	120		37,00
DF200	200		32,00
DF400	400		24,00
DF500	500		21,00
DF1500	1500		21,00
DF3000	3000		23,00

MONDRILLO

NEW 2025

IT Mole diamantate per taglio e levigatura
 GB Diamond cup wheels for cutting and grinding
 ES Muelas de diamante para el cortar y rectificar

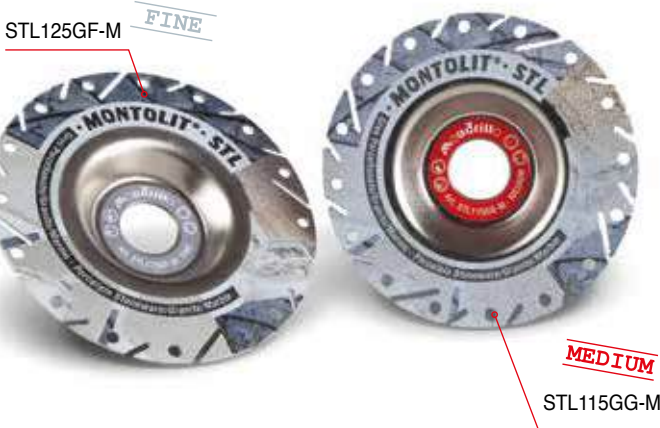

Gres porcellanato/Ceramica delicata/Marmo/Vetro
 Porcelain stoneware/Soft ceramic/Marble/Glass
 Gres porcelánico/Cerámicas delicadas/Mármol/Vidrio

Art.	Ø		Ø		EURO
	mm	inch	mm *		
STL115GF-M	115	4,5	22,2		123,00
STL125GF-M	125	5	22,2		127,00

* 5/8 inch: Riduzione a richiesta • Reduction on request • Reducción a pedido

Gres porcellanato/Granito/Pietra/Cemento
 Porcelain stoneware/Granite/Stone/Concrete
 Gres porcelánico/Granito/Piedra/Hormigón

Art.	Ø		Ø		EURO
	mm	inch	mm *		
STL115GG-M	115	4,5	22,2		123,00
STL125GG-M	125	5	22,2		127,00

* 5/8 inch: Riduzione a richiesta • Reduction on request • Reducción a pedido

MONDRILLO

IT Platorelli diamantati multiuso
 GB Diamond multipurpose grinding wheels
 ES Platos diamantados multiuso



FINE

Gres porcellanato/Ceramica delicata/Marmo/Vetro
 Porcelain stoneware/Soft ceramic/Marble/Glass
 Gres porcelánico/Cerámicas delicadas/Mármol/Vidrio

Art.	Ø		Ø		EURO
	mm	inch	mm		
PE115GF	115	4,5	22,2 *		71,00
PEBS115GF	115	4,5	M14		114,00

* 5/8 inch: Riduzione a richiesta • Reduction on request • Reducción a pedido

Gres porcellanato/Granito/Pietra/Cemento/Mattoni
 Porcelain stoneware/Granite/Stone/Concrete/Bricks
 Gres porcelánico/Granito/Piedra/Hormigón

MEDIUM

Art.	Ø		Ø		EURO
	mm	inch	mm		
PE115GG	115	4,5	22,2 *		71,00
PEBS115GG	115	4,5	M14		114,00

* 5/8 inch: Riduzione a richiesta • Reduction on request • Reducción a pedido

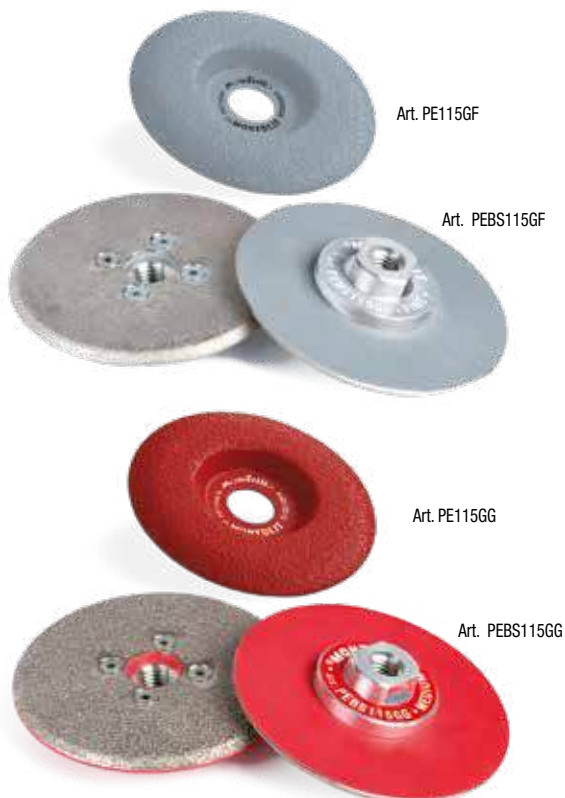

FLEXIMONT

IT Dischi diamantati lamellari
 GB Lamellar diamond blades
 ES Discos de diamante lamelar



pg. 107
 Espositore
 Display
 Expositor

Art.	Grana / Grain / Grueso	Ø		mm*	EURO
		mm	inch		
FLEXIMONTGG	grossa / coarse / grueso	115	4,5	22,2	75,00
FLEXIMONTGM	media / medium / medio	115	4,5	22,2	72,00
FLEXIMONTGF	fine / fine / fino	115	4,5	22,2	72,00

* 5/8 inch: Riduzione a richiesta • Reduction on request • Reducción a pedido

Gres porcellanato/Ceramica/Granito/Marmo/Vetro
 Porcelain stoneware/Ceramic/Granite/Marble/Glass
 Gres porcelánico/Cerámica/Granito/Mármol/Vidro



FLEXIMONT - Super Aluminium

IT Dischi diamantati lamellari
 GB Lamellar diamond blades
 ES Discos de diamante lamelar



Art.	Grana / Grain / Grueso	Ø		mm*	EURO
		mm	inch		
FLEXIMONT-S-GG	grossa / coarse / grueso	115	4,5	22,2	89,00
FLEXIMONT-S-GM	media / medium / medio	115	4,5	22,2	86,00
FLEXIMONT-S-GF	fine / fine / fino	115	4,5	22,2	86,00

* 5/8 inch: Riduzione a richiesta • Reduction on request • Reducción a pedido

Gres porcellanato/Ceramica/Granito/Marmo/Vetro
 Porcelain stoneware/Ceramic/Granite/Marble/Glass
 Gres porcelánico/Cerámica/Granito/Mármol/Vidro

Corpo in alluminio
 Aluminium body
 Marco de aluminio



MONDRILLO

- IT Platorello per rimozione colla ed epossidico
 GB Diamond cup wheel remover for glue and epoxy
 ES Plato para retiro de pegamento y epoxídico



Art.	Ø		Ø		EURO
	mm	inch	mm*		
PEM115	115	4,5	22,2		107,00
PEM125	125	5	22,2		129,00

* 5/8 inch: Riduzione a richiesta • Reduction on request • Reducción a pedido

Adesivo/Colla/Epossidico/Guaina/Intonaci/Resine
 Adhesive/Glue/Epoxy Resin/Sheaths/Plasters/Resins
 Adhesivo/Pegamento/Resina Epoxi/Vainas/Recubrimientos/Resinas



Adattatore 22,2mm / M14
 Adapter 22,2mm / M14
 Racor 22,2mm / M14

Art. AUM14

EURO 15,00

PLUME

- IT Mola diamantata sinterizzata per levigatura
 GB Sinterized diamond grinding cup wheel
 ES Muela de diamante sinterizada para el pulido



Speciale per macchine a batteria
 Special for cordless machine
 Especial para máquinas de batería



Art.	Ø		Ø		EURO
	mm	inch	mm*	g	
PLUME100	100	4	M14	144	113,00
PLUME125	125	5	M14	216	183,00

* 5/8 inch: Riduzione a richiesta • Reduction on request • Reducción a pedido

Edilizia/Gres Porcellanato/Granito
 Building Material/Porcelain Stoneware/Granite
 Construcción/Gres Porcelánico/Granito



Corpo in polimero ultraleggero
 Body in ultralight polymer
 Montura de polimero ultra ligero

TRITONE

- IT Mole diamantate sinterizzate per levigatura
- GB Sinterized diamond grinding cup wheels
- ES Muelas de diamante sinterizada para el pulido



Art.				EURO
	mm	inch		
TRITONE100	100	4	M14	140,00
TRITONE115	115	4,5	22,2 *	144,00
TRITONE125	125	5	22,2 *	154,00
TRITONE150	150	6	22,2 *	192,00
TRITONE180	180	7	22,2 *	212,00

* 5/8 inch: Riduzione a richiesta • Reduction on request • Reducción a pedido

Calcestruzzo/Materiali lapidei/Gres porcellanato/Rimozione colla e epossidico

Concrete/Stone materials/Porcelain stoneware/Glue and epoxy removal

Hormigón/Materiales pétreos/Gres porcelánico/Eliminación de pegamento y epoxi



VORTEX

- IT Platorello universale scheletrato
- GB Universal diamond cup wheel
- ES Plato universal



Art.				EURO
	mm	inch		
PUSV125	125	5	22,2 *	128,00
PUSV150	150	6	22,2 *	172,00
PUSV180	180	7	22,2 *	218,00

* 5/8 inch: Riduzione a richiesta • Reduction on request • Reducción a pedido

Calcestruzzo/Materiali lapidei

Concrete/Stone materials

Hormigón - Materiales pétreos



Adattatore 22,2mm / M14
Adapter 22,2mm / M14
Racor 22,2mm / M14

Art. AUM14

EURO 15,00

TURBO

IT Mole diamantate per levigatura
 GB Diamond grinding cup wheels
 ES Muelas de diamante para el pulido



Art.	Ø		Ø		EURO
	mm	inch	mm		
PUT115	115	4,5	22,2 *		116,00
PUT125	125	5	22,2 *		135,00

* 5/8 inch: Riduzione a richiesta • Reduction on request • Reducción a pedido

Granito/Calcestruzzo - Granite/Concrete - Granito/Hormigón

Art. AUM14		Adattatore 22,2mm / M14
EURO 15,00		Adapter 22,2mm / M14 Racor 22,2mm / M14

SECTOR

IT Mole diamantate per levigatura
 GB Diamond grinding cup wheels
 ES Muelas de diamante para el pulido



Art.	Ø		Ø		EURO
	mm	inch	mm		
PUSC100M14	100	4	M14		89,00
PUSC115	115	4,5	22,2 *		82,00
PUSC125	125	5	22,2 *		96,00
PUSC150	150	6	22,2 *		130,00
PUSC180	180	7	22,2 *		164,00

* 5/8 inch: Riduzione a richiesta • Reduction on request • Reducción a pedido

Calcestruzzo/Materiali lapidei - Concrete/Stone materials
 Hormigón/Materiales pétreos

Art. AUM14		Adattatore 22,2mm / M14
EURO 15,00		Adapter 22,2mm / M14 Racor 22,2mm / M14

SECTOR

IT Mole diamantate per levigatura
 GB Diamond grinding cup wheels
 ES Muelas de diamante para el pulido



Art.	Ø		Ø		EURO
	mm	inch	mm		
PUSA115	115	4,5	22,2 *		82,00
PUSA125	125	5	22,2 *		96,00
PUSA180	180	7	22,2 *		164,00

* 5/8 inch: Riduzione a richiesta • Reduction on request • Reducción a pedido

Materiali abrasivi - Abrasive materials - Materiales abrasivos

Art. AUM14		Adattatore 22,2mm / M14
EURO 15,00		Adapter 22,2mm / M14 Racor 22,2mm / M14

DISPLAY

Art. 400P5C

pg. 4
 Prodotto
 Product
 Producto



Art. 400FL3

pg. 28
 Prodotto
 Product
 Producto



Art. 400BTL

pg. 34
 Prodotto
 Product
 Producto



Art. 400CGX

pg. 61
 Prodotto
 Product
 Producto



Art. 400FUXT

pg. 68
 Prodotto
 Product
 Producto



Art. 400FAJEX

pg. 86
 Prodotto
 Product
 Producto



Art. 400FT-S

pg. 91
 Prodotto
 Product
 Producto



Art. 400FLEXI

pg. 103
 Prodotto
 Product
 Producto



Espostore vuoto IN PROMOZIONE, a richiesta. Condizioni particolari: contattare Agente di zona e/o ufficio vendite Brevetti MONTOLIT.
 Empty display FREE of charge, on request. Please call Brevetti MONTOLIT sales department for special sales conditions.
 Expositor vacía EN PROMOCIÓN, previa solicitud. Condiciones especiales: ponerse en contacto con el oficina de ventas MONTOLIT.

TOTEM

IT Espositori
GB Displays
ES Expositores



Art. 960D

Art. 960

Art. 960S



Art. 960G



Art.

EURO

960M	Expo macchine ed utensili - <i>Expo machine & tools</i> - <i>Expo máquinas y herramientas</i>	104x45x234 cm - 40x18x92-1/8"	380,00
960DM	Expo utensili diamantati - <i>Expo diamond tools</i> - <i>Expo herramientas de diamante</i>	104x45x234 cm - 40x18x92-1/8"	330,00
960S	Serrature di sicurezza - <i>Security locks</i> - <i>Cerraduras de seguridad</i>	set 30 pcs.	82,00
960G	Ganci doppi per pannello forato - <i>Double hooks for perforated panel</i> - <i>Ganchos dobles para tablero perforado</i>	set 10 pcs.	46,00

TOTEM MASTERPIUMA

IT Espositore Masterpiuma
GB Masterpiuma display
ES Expositor Masterpiuma

Art.

EURO

960MP	(79x60x203h cm - 31x23,5x78 inch)	190,00
-------	-----------------------------------	--------



Condizioni particolari: contattare Agente di zona e/o ufficio vendite Brevetti MONTOLIT.
Please call Brevetti MONTOLIT sales department for special sales conditions.
Condiciones especiales: ponerse en contacto con el oficina de ventas MONTOLIT.

CONDIZIONI GENERALI DI VENDITA

IL PRESENTE LISTINO ANNULLA E SOSTITUISCE I PRECEDENTI

Si invita, chi pubblicizza i prodotti MONTOLIT, a rispettare il presente listino perchè parametrato a tutela del nome e dell'immagine MONTOLIT sul mercato.

L'ordine s'intende conferito od assunto "salvo approvazione della casa" e tale approvazione viene anche manifestata con la sola pratica evasione dell'ordine stesso. Con il conferimento dell'ordine si intendono accettate, senza riserve, da parte del committente, le seguenti condizioni:

- 1) Resa: franco partenza nostre officine di Cantello con spedizione in:
 - a) porto franco - con addebito in fattura - se il trasporto viene effettuato tramite corrieri con noi convenzionati.
 - b) porto assegnato - qualora venga richiesto dal cliente il trasporto con corriere diverso da quello con noi convenzionato.
- 2) Per eventuali richieste di spedizioni con caratteristiche diverse dalle abituali (es.: pacco postale, espresso, pacco aereo, ecc.) il costo verrà addebitato secondo tariffe da noi stabilite.
- 3) Gli ordini vengono evasi secondo le disponibilità di magazzino, senza garanzie di saldo. Le eventuali rimanenze saranno inviate appena disponibili. Trascorsi 90 gg. dalla data di prima spedizione, ogni rimanenza inevasa sarà annullata.
- 4) Le illustrazioni, le caratteristiche e tutte le altre indicazioni descritte sul catalogo s'intendono approssimative, riservandoci di apportare tutte quelle modifiche che, a nostro giudizio, costituiscono migliorie, senza che ciò possa giustificare reclamo da parte del committente.
- 5) La merce viaggia a rischio e pericolo del committente, anche se venduta franco destino; pertanto per ogni ammanco, per eventuali ritardi e per ogni disagio, dovrà essere rivolto reclamo al vettore unico responsabile. Si raccomanda di controllare lo stato della merce, i pesi e il n° colli prima di prendere in consegna la merce. Da parte nostra, daremo tutta la collaborazione possibile per mettere il committente in condizioni di presentare reclamo.
- 6) Eventuali lamentele per difetti saranno prese in considerazione solo entro otto giorni dal ricevimento della merce.
- 7) I pagamenti dovranno essere effettuati, nei termini concordati, esclusivamente alla nostra sede o a persone da noi autorizzate e non sono ammesse trattenute arbitrarie ed arrotondamenti. Per i pagamenti ritardati saranno conteggiati interessi di banca.
- 8) Trascorsi 30 gg. dal termine di pagamento s'intende revocato ogni sconto di pagamento e pertanto le fatture dovranno essere pagate per intero.
- 9) I materiali sono garantiti per qualità e lavorazione. Ciò comporta la loro sostituzione o accredito, a nostro giudizio, la loro riparazione, a condizione che:
 - a) il reso ci pervenga in porto franco, con autorizzazione al reso, altrimenti verrà respinto;
 - b) i materiali presentino evidenti difetti di costruzione e di qualità che dovranno essere indicati sulla bolla che accompagna il reso. **SULLA STESSA È INDISPENSABILE INDICARE ANCHE IL RIFERIMENTO DELLA FORNITURA (N° FATTURA, DATA, ECC.), SECONDO LE VIGENTI DISPOSIZIONI FISCALI;**
- c) non saranno sostituiti, né riparati gratuitamente, restando a disposizione del committente, i prodotti che risultassero guastati per imperizia o manomissione o per adattamento ad usi diversi da quelli ai quali sono destinati.
- 10) La garanzia esclude qualsiasi rivalsa per danno e spese di ogni genere.
- 11) **RESI DI MERCÉ PER ERRORI DI ORDINAZIONE O PER MOTIVI NON IMPUTABILI ALLA DIREZIONE DELL'AZIENDA CHE, SARANNO ACCETTATI SOLO SE:**
 - PREVENTIVAMENTE AUTORIZZATI DALLA DIREZIONE E SPEDITI IN PORTO FRANCO;
 - LA MERCE RESA DOVRÀ ESSERE INTATTA, SIGILLATA NELLA CONFEZIONE ORIGINALE E NON ACQUISTATO DA OLTRE 12 MESI. LA MERCE RESA, SE RISCOSTRATA IN PERFETTO STATO, SARÀ ACCREDITATA NEL VALORE FATTURATO MENO IL 10% QUALE CONCORSO SPESE PER LE OPERAZIONI AMMINISTRATIVE, CONTROLLO E REIMMAGAZZINAGGIO. PER ECCEZIONALI RESI DI MERCE ACQUISTATI DA OLTRE 12 MESI, SARÀ INDISPENSABILE RICHIEDERE LA PREVENTIVA AUTORIZZAZIONE ALLA DIREZIONE DELL'AZIENDA CHE ESPRIMERÀ PARERE INSINDACABILE CIRCA L'ACCETTAZIONE DEL RESO STESSO E LA RELATIVA QUOTAZIONE.
- 12) I.V.A., tasse ed ogni altro onere fiscale sono a carico del committente.
- 13) Per qualsiasi contestazione si riconosce esclusiva competenza al TRIBUNALE DI VARESE.

ATTENZIONE:

- Per ogni ordinazione indicare sempre il numero di articolo.
- Per ogni ordinazione attenersi all'unità di vendita e relativo multiplo. La casa si ritiene autorizzata a modificare d'ufficio eventuali quantità non corrispondenti all'unità di vendita.

GARANZIA

MACCHINE ED ATTREZZATURE: per tutte le attrezzature MONTOLIT è riconosciuta una garanzia di 2 (due) anni a partire dalla data di vendita (fattura / bolla di consegna / scontrino fiscale). Tagliapiastrelle, forapiastrelle, tranciaccolchi e tagliategole manuali sono coperti da garanzia a vita su eventuali difetti di costruzione (riconosciuti a giudizio esclusivo dell'Ufficio Tecnico della Brevetti MONTOLIT S.p.A.). Guasti derivanti da un uso non conforme o da normale usura sono esclusi dalle presenti garanzie.

UTENSILI DIAMANTATI: viene riconosciuta totalmente, a giudizio dell'Ufficio Tecnico della Brevetti MONTOLIT S.p.A., su dischi appena usati e non ancora consumati che presentino evidenti difetti di fabbricazione. La garanzia non verrà riconosciuta per i dischi deteriorati in seguito al loro uso per tagli di materiali diversi da quelli per i quali sono stati specificamente prodotti. Reclami riguardanti qualsiasi disco da taglio consegnato saranno accettati solamente se il consumo dell'altezza della fascia diamantata non abbia superato il 20%.

Da sempre, la Brevetti MONTOLIT impiega e fornisce materiali di prima scelta. Si tratta di un impegno di serietà e moralità commerciale che eleva la Nostra Azienda al di sopra dello standard. Sicurezza e garanzia del prodotto costituiscono per noi motivo di vanto. Una realtà operativa che non è fatta solo di parole, ma anche di vere e proprie garanzie scritte. Infatti assicuriamo tutti i nostri prodotti contro i danni involontariamente cagionati in conseguenza di un fatto accidentale verificatosi per difetto di costruzione e fabbricazione del prodotto anche dopo la sua consegna e commercializzazione.

SYMBOLOGIA • SYMBOLOGY • SIMBOLOGÍA

	Lunghezza massima di taglio Maximum cutting length Longitud máxima de corte		Attacco fresa Connection for cutter Conexión para fresa		Potenza motore Motor power Potencia del motor												
	Lunghezza di taglio in diagonale Diagonal cutting length Longitud de corte en diagonal		Attacco fresa Connection for cutter Conexión para fresa		Smerigliatrice angolare Electric angle grinder Lijadora angular												
	Spessore massimo di taglio Maximum cutting thickness Espesor máximo de corte		Attacco fresa Connection for cutter Conexión para fresa		Scanalatore Wall Chaser Rozadora												
	Potenza di spacco Power breaking Potencia de ruptura		Dimensioni Dimensions Dimensiones		Taglierina elettrica ad acqua Electric, water-cooled diamond tilesaw Cortadora eléctrica con agua												
	Peso Weight Peso		Altezza Height Altura		Taglierina elettrica ad acqua Electric, water-cooled diamond tilesaw Cortadora eléctrica con agua												
	Diametro fresa Cutter diameter Diámetro del cortador		Tipo o numero batterie Battery type or number Tipo o número de batería		Taglierina da cantiere Sitting saw cut-off machine Cortadora de mesa												
	Diametro e foro disco Blade and central bore diameter Diámetro y orificio del disco		Tempi di ricarica batterie Battery charging times Tiempos de carga de la batería		Troncatura Cutting-off machine Máquina cortadora												
	Attacco mola/piatrello Connection for cup wheel Conexión para muela		Connettore USB USB connector Conector USB		Taglia pavimenti Floor cutting machine Corta pavimentos												
	Non ammesso l'uso della percussione Not permitted for use with percussion drill No permitido el uso de percusión		Portata Flow rate Caudal		Sistema motorizzato MOTOFLASH Motorized system MOTOFLASH Sistema motorizado MOTOFLASH												
	Numero di segmenti Number of segments Número de segmentos		Non ammesso l'uso a secco Not permitted for dry cutting-off No permitido el uso en seco		Elettroforatrice ad acqua Water type electrical drilling machine Perforadora eléctrica con agua												
	Spessore del disco Thickness of blade Espesor del disco		Utilizzo a secco Dry use Utilizar en seco		Trapano/Carotatrice manuale Power drill Perforadora manual												
	Imballo / Packing / Embalaje		Utilizzo a secco con aspirazione Dry use with aspiration Uso en seco con aspiración		Trapano a batteria Cordless drill Taladro inalámbrico												
	<table border="1"> <thead> <tr> <th>B = Blister</th> <th>Unità</th> </tr> </thead> <tbody> <tr> <td>C = Cartone/Carton/ Cartón</td> <td>1</td> </tr> <tr> <td>S = Scatola/Box/Caja</td> <td>2</td> </tr> <tr> <td>T = Sacchetto/Sack/Saco</td> <td>3</td> </tr> <tr> <td>V = Non imballato/Not packed/Sin embalaje</td> <td>...</td> </tr> <tr> <td></td> <td>...</td> </tr> </tbody> </table>	B = Blister	Unità	C = Cartone/Carton/ Cartón	1	S = Scatola/Box/Caja	2	T = Sacchetto/Sack/Saco	3	V = Non imballato/Not packed/Sin embalaje		Utilizzo ad umido Wet use Utilizar en mojado		Carotatrice professionale a telaio Professional core drilling machine with frame Perforadora profesional con soporte
B = Blister	Unità																
C = Cartone/Carton/ Cartón	1																
S = Scatola/Box/Caja	2																
T = Sacchetto/Sack/Saco	3																
V = Non imballato/Not packed/Sin embalaje	...																
	...																

GENERAL TERMS OF SALE

THIS PRICE-LIST CANCELS AND REPLACES FORMER ONES

We invite MONTOLIT promoters, to follow and respect the current price list being the reflection of the name and image of MONTOLIT on the market. By placing the order the customer accepts without reserve the following conditions:

- 1) Goods are delivered ex our warehouse in Cantello (VA) - Italia.
- 2) Upon customer's request for a delivery: EX ITALIAN WAREHOUSE - F.O.B. - C&F - C.I.F. - or other ones to a place of his choice, the cost of either one of these deliveries will be invoiced to him.
- 3) Goods travel at consignee's risk even if under terms of sale: free place of destination.
- 4) Complaints for defects or statements of shortage of goods will be taken into consideration within 8 days from receipt of the goods, without prejudice to the disposition on point 3.
- 5) PAYMENTS MUST BE ABSOLUTELY CARRIED OUT WITHIN THE AGREED UPON TERMS.
- 6) The cost for special packing will be invoiced at cost price.
- 7) Foreign bank charges will be charged to the customer's account.
- 8) Any dispute between the parties will be submitted TO ARBITRATION IN VARESE (ITALY) before the competent COURT under its rules.

CONDICIONES GENERALES DE VENTA

ESTA LISTA DE PRECIOS CANCELA Y SUSTITUYE LAS ANTERIORES

Invitamos los promotores de productos montolit, a respetar esta lista de precios porque está parametrizada para proteger el nombre y la imagen de montolit en el mercado.

- Al realizar el pedido, el cliente acepta sin reserva las siguientes condiciones:
- 1) Los bienes se entregan desde nuestro almacén en Cantello (VA) - Italia.
 - 2) Ante el pedido de un cliente para una entrega: DESDE EL ALMACÉN - F.O.B. - C&F - C.I.F. - u otros a un lugar de su elección, el coste de cualquiera de estas entregas se cargará a su nombre.
 - 3) Los bienes se transportan a riesgo del destinatario, incluso bajo las condiciones de venta: libre lugar de destino.
 - 4) Las reclamaciones por defectos o declaraciones de falta de mercancías se tendrán en cuenta dentro de los 8 días de recepción de las mercancías, sin perjuicio de lo dispuesto en el punto 3.
 - 5) EL PAGO SE DEBERÁ EFECTUAR ABSOLUTAMENTE DENTRO DE LOS TÉRMINOS ACORDADOS.
 - 6) El coste de un embalaje especial se cargará al precio del coste.
 - 7) Los gastos bancarios del extranjero se cargarán a cuenta del cliente.
 - 8) Cualquier controversia entre las partes se enviará PARA SU RESOLUCIÓN EN VARESE (ITALIA) frente al TRIBUNAL competente según sus leyes.

WARRANTY

MACHINES AND EQUIPMENT: all MONTOLIT tools are covered by a 2 (two) years warranty starting from the date of sale (proof provided by an invoice, delivery note or fiscal receipt). Manually operated tile cutters, tile drills, block cutters and roof tile cutters are covered by a lifetime warranty (claims allowed at the sole discretion of Brevetti MONTOLIT S.p.A. Engineering Department) in respect of construction defects. Defects resulting from improper use or from normal wear and tear are excluded from the terms of these warranties.

DIAMOND TOOLS: it is wholly acknowledged by Brevetti MONTOLIT S.p.A. Technical Office, for discs barely used and not yet worn out, which present clearly visible manufacturing defects. This guarantee does not cover discs used for cutting materials different from the ones they have been manufactured for. Complaints on any delivered diamond cutting discs will only be accepted if the wear of the rim height does not exceed 20%.

Brevetti MONTOLIT has always employed and supplied top quality materials and products. Our professional commitment to our customers places us well above the common standard. We take great pride in the safety and reliability of our products. Commitment to quality is not just an idle boast-our products are covered by full written warranties. In fact, we insure all our products against accidental damage due to manufacturing defects and poor workmanship after sale and delivery.

GARANZIA

MAQUINAS Y EQUIPOS: para todos los equipos MONTOLIT se reconoce una garantía de 2 (dos) años a partir de la fecha de venta (factura / justificante de entrega/ticket de compra). Las cortadoras de baldosas, perforadoras de baldosas, cortadoras de bloques y cortadoras de tejas manuales están cubiertas por una garantía de por vida sobre defectos de fabricación (reconocidos solamente por juicio exclusivo por el Servicio Técnico de la Firma MONTOLIT S.p.A.). Problemas derivados de un uso inadecuado o por un uso normal se excluyen de las garantías presentes.

HERRAMIENTAS DIAMANTADORAS: es reconocida totalmente, a juicio del Servicio Técnico de la Firma MONTOLIT S.p.A., sobre discos apenas utilizados y aún no consumidos que presenten evidentes problemas de fabricación. La garantía no será reconocida para aquellos discos que estén deteriorados a causa de su uso para cortar materiales diversos a aquellos de los cuales para los que han sido concretamente fabricados. Aquellas reclamaciones que relacionen a cualquier disco de corte serán aceptadas solamente si el desgaste de la altura de la franja diamantada no ha superado el 20%.

Desde siempre, la Firma MONTOLIT utiliza y entrega materiales de primera calidad. Se trata de un empeño de seriedad y moralidad comercial que eleva a Nuestra Empresa por encima de los estándares de calidad. La seguridad y la garantía del producto constituyen para nosotros un motivo de orgullo. Una realidad operativa que no está constituida solamente de palabras, pero también de verdaderas y reales garantías escritas. Aseguramos todos nuestros productos contra daños involuntarios a causa de un accidente provocado a causa de defectos de construcción y fabricación del producto después de su entrega y comercialización.



1946

Brevetti Montolit S.p.A.

Sedi operative | *Company headquarters* | *Sede de la empresa:*

Largo Cav. Montoli - 21050 Cantello (VA) Italy

Via Varese 4/A - 21050 Cantello (VA) Italy

Sede legale | *Legal head office* | *Sede legal:*

Via Turconi, 25 - 21050 Cantello (VA) Italy

Tel. ++39 0332 419 211

Fax ++39 0332 418 444

info@montolit.com

SERVIZIO CLIENTI / CUSTOMER SERVICE



service@montolit.com

Per consigli e soluzioni tecniche
For advice and technical solutions
Para asesoramiento y soluciones técnicas

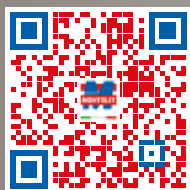

montolit.com



Montolit è partner tecnico delle seguenti scuole e associazioni:
Montolit is a technical partner of the following schools and associations:
Montolit es socio técnico de las siguientes escuelas y asociaciones:

Associata con: | *Associated with:* | *Asociado con:*



Rivenditore autorizzato | *Authorised dealer* | *Distribuidor autorizado:*



Descrizioni ed illustrazioni si intendono fornite a semplice titolo indicativo. La Casa si riserva il diritto, ferme restando le caratteristiche essenziali dei modelli qui descritti ed illustrati, di apportare ai propri prodotti, in qualunque momento, e senza preavviso, le eventuali modifiche da essa ritenute necessarie a scopo di miglioramento o per qualsiasi esigenza di carattere costruttivo o commerciale.

Descriptions and illustrations are purely indicative. Without prejudice to the essential features of the models described and illustrated herein, the Company reserves all rights of marking product changes and without notice at any moment considered necessary for improvement of required in the interest of product engineering and sale.

Las descripciones y las ilustraciones son entregadas como simple título indicativo. La Casa fabricante se reserva el derecho, de mantener las características esenciales de los modelos aquí descritas e ilustrados, y de aportar a sus mismos productos, en cualquier momento, y sin aviso previo, modificaciones consideradas necesarias para su mejora o para cualquier exigencia de carácter constructivo o comercial.